



Essay on repeater watches

By
**François
Crespe**

Revised Edition
Translated and augmented by
Richard Watkins



Essay
on
Repeater
Watches
(revised)

By
François Crespe

Translated and augmented by
Richard Watkins

Kingston, Tasmania, Australia
Published by Richard Watkins
December, 2006

© Copyright 2006 Richard P. Watkins
Revised March 2007

ISBN 978-0-9581369-8-3

Translated from: François Crespe *Essai sur les montres a répétition* Geneva, J J Paschoud, 1804.

Covers: The cover photographs are of a quarter repeater circa 1790, made by Des Arts & Comp, Geneva.

Other translations and books by Richard Watkins:

Ferdinand Berthoud and Jacob Auch: *How to make a verge watch*, (1763 and 1827) 2005 (ISBN 0-9581369-6-3) (with E.J. Tyler)

Jacques David: American and Swiss watchmaking in 1876, reports to the International Committee of Jura Industries on the manufacture of watches in the United States, (1877) 2003 (ISBN 0-9581369-2-0)

E. Favre-Perret: Philadelphia Exhibition 1876, report presented to the Federal High Council on the Horology Industry, (1877) 2004

André Francillon: History of Longines preceded by an essay on the Agassiz comptoir, (1947) 2005 (ISBN 0-9581369-7-1)

Emile Graupmann: The finishing of the watch case, (1910) 2004

Moritz Grossmann: Prize essay on the construction of a simple and mechanically perfect watch, (1880) 2002 (ISBN 0-9581369-0-4)

Bruno Hillmann: The keyless mechanism, a practical treatise on its design and repair, (ca1920) 2004

Jerome Lalande: *Jerome Lalande, diary of a trip to England 1763*, (1763) 2002 (ISBN 0-9581369-1-2)

Societe Suisse de Chronometrie: Some notes on Pierre-Frederic Ingold and the work of E. Haudenschild, (1932), 2004

Richard Watkins: Mechanical Watches, an Annotated Bibliography of Publications since 1800, 2004 (ISBN 0-9581369-5-5)

These are available from www.watkinsr.id.au

Articles by Richard Watkins:

Jacques David—and a Summary of “American and Swiss Watchmaking in 1876” with Emphasis on Interchangeability in Manufacturing, NAWCC Bulletin, No. 350 (June 2004): pp. 294-302.

Berthoud, Harrison, and Lalande: A Near Myth, NAWCC Bulletin, No. 359 (December 2005): pp. 773-743.

These are also available from www.watkinsr.id.au

ESSAI
SUR LES MONTRES

A

RÉPÉTITION,

*Dans lequel on traite toutes les parties
qui ont rapport à cet art, en forme
de dialogue, à l'usage des horlogers;*

PAR FRANÇOIS CRESPE, de Genève.

*Approuvé par la Société pour l'avancement des
arts de Genève.*



A GENÈVE,

Chez J. J. PASCHOUX, Libraire.

AN XII. — 1804.

Contents

Introduction	7
Preface	8
François Crespe	8
The translation	8
References	9
Action of a verge repeater	10
Continuous motion and discrete states	10
Terminology	10
The basics - the repeater-train	10
The order of striking	11
Counting the hours and quarters	11
Operating the hammers	12
Simple but useless!	13
The all-or-nothing piece	14
The hour-pallet large-hammer lifting pin	14
The star-wheel and jumper	15
The surprise-piece	16
Hand setting	18
The half quarter repeater	18
Alarm mechanisms	20
Alarm with moving dial	20
Alarm with fixed dial	21
Tables of terminology	24
Illustrations	26
Essay on Repeater Watches	35
Preface	39
Plan of the book	39
Definitions	41
Part 1 - Repeater-work	47
Lesson 1 - The origin of horology	47
Lesson 2 - Divisions of clock and watchmakers	48
Lesson 3 - The characteristics of a good watchmaker	49
Lesson 4 - Construction of repeater-work	51
Repeater-work	51
Tracing the calibre	51
Repeater-work frame key-screws	52
The hour-rack, hammers and lifting pallets	53
Springs	53
The silencer	54
The winding-rack and its action with the pulleys	55
The quarter-rack and its pallets	56
The all-or-nothing piece	57
The star-wheel and its action with the jumper	58
The hour-snail	58
The quarter-snail	59
The surprise-piece	59
The quarter-rack spring	60
The fastening spring or dial spring	60
Counter-springs	60
Hardening and straightening pieces	60
Motion work	61
Functioning of the repeater-work.	61

Essay on Repeater Watches

Lesson 5 - Half-quarter repeaters and alarms	63
Half-quarter repeaters	63
Dial-work for alarms	63
Alarm with two hammers	64
Alarm with a hammer using a lever escapement	65
Various detents for alarms	65
Minute alarms	66
Part 2 - Casing	67
Lesson 6 - Setting up repeater-work with bells and gongs	67
Definition of sound bodies	67
Placing the bell in the case	67
The best forms for cases	68
Lesson 7 - Casing repeaters with a bell	70
Continuation of casing, preparation of the hinge	71
The dial spring (closing spring)	72
Adjusting the hammers	72
The touch piece	72
Lesson 8	74
The push-piece action and functions of the repeater-work	74
Adjustment of the dial	74
Continuation of the functions and assembly of the repeater-work	75
Repeaters with dust caps	76
Assembly of dumb repeaters	76
Assembly of repeaters with double cases, called English repeaters	77
Part 3 - Finishing	78
Lesson 9	78
Finishing the repeater-work	79
Lesson 10	81
Friction	81
Gilded reassembly	81
Oiling repeaters	82
Compendium of the faults which most frequently stop the action of repeater-work	84
Stoppages caused by the silencer	84
Stoppages caused by the pulleys	85
Stoppages caused by the chain	85
Stoppages caused by the winding-rack	85
Stoppages caused by the quarter-rack	85
Stoppages caused by the spring of the two large-hammer pallets, called the double action	87
Stoppages of the pallet of the small-hammer, caused by the counter-spring	87
Stoppage caused by the all-or-nothing piece	87
Stoppages caused by star, the hour-snail and the jumper	88
Stoppages caused by the surprise-piece	89
Stoppages caused by the quarter-snail	89
Stoppages of repeaters by the case	89
Causes which stop the vibrations of the bell	90
Particular causes which stop the vibrations of the bell	90
Particular causes which stop the action of the repeater-work	91
Stoppage at 12 hours	92
Another stop at 12 hours	92
A problem of another type	93
Unexpected stoppage of the movement	93
Stop by the delay	93
Unforeseen case	93
Movement of the hands by pushing the repetition	94
How to find the causes which stop the functions of repeater watches	94
The steps to examine the repeater mechanism to secure its actions	95

Introduction

François Crespe

Preface

François Crespe

Although only a small book, François Crespe's *Essai sur les montres à répétition* has 284 pages and not one illustration. It has sat in my bookcase for many years and I have occasionally wondered how anyone could write so much on such a technical topic without at least one drawing. And I have also wondered how important or irrelevant his book may be compared with other writing on repeaters.

Very little is known about Crespe. Baillie *Watchmakers and clockmakers of the world* has the brief entry: "Geneva, 1792-1804, director of the state factory; wrote *Essai sur les montres à répétition*". To which Patrizzi *Dictionnaire des horlogers genevois* adds: "Conceived of and replaced the bell by gongs in repeaters in 1792." And Eugène Jaquet mentions Crespe in his preface to Lecoultré *A guide to complicated watches*, without adding to our knowledge. Part of the problem is that Crespe made repeater-work. Consequently we would not expect to see his name on watches, as his work would have been incorporated in watches sold under other signatures. His book also indicates that he was involved with the education of repeater-work makers.

This scant information tells us nothing useful and we must rely upon his writing in order to assess him. As everyone has heard of Thiout, Lapaute, Berthoud and other major French authors (even though I suspect not many have actually read them), I decided it was time we had a chance to know of Crespe.

Essai sur les montres à répétition, published in 1804, is *not* a superficial, descriptive book. It is a comprehensive, detailed explanation of how to make repeater-work. It was written for experienced workmen who already had the skills to make a watch by hand and who were familiar with the verge quarter repeater. Consequently, Crespe had no need to include illustrations of mechanisms of which his readers had detailed knowledge, and no need to discuss how they worked. His sole aim was to teach workmen the finer arts of making them and, in doing so, he has also provided us with an insight into 18th century watchmaking techniques.

The book is in two sections.

The first section has 205 pages and is in a question and answer format. It examines repeater-work in the order in which it is made, which is totally different from the order in which it would be described to explain its action. Crespe begins with instructions on how to draw the calibre and make the repeater-work frame to hold the mechanism. He then goes on to explain how to make each part, omitting those (such as the spring barrel) with which the reader would already be competent. To say that he explains how to make repeater-work is a little misleading. With springs, for example, he assumes the reader can make them and he concentrates on their shape, strength and hardening; areas in which he feels the ordinary watchmaker needs guidance.

After a short digression to explain half-quarter repeaters and alarms, Crespe next examines how to case a repeater with either a bell or gongs. Finally he describes finishing the mechanism; the examination and correction of faults, examination after gilding and oiling.

The second section is a compendium of faults. In it Crespe details the problems that can cause a repeater to stop or function incorrectly, and how such faults can be rectified.

The translation

I began this translation in February 2001. However, I found Crespe a greater challenge than my previous translations. The most obvious hurdle is his punctuation; he happily wrote "sentences" of over a page in length, full of commas, semi-colons and colons, and often discussing several different things! This, coupled with using some words in rather odd ways, means that in places he seems almost unintelligible. However, with one or two exceptions the meaning can be clearly deduced from context.

Over the following years I looked at Crespe now and then, always to get a bit further before being distracted by easier tasks.

To comprehend him and improve my knowledge, I re-examined other books on verge repeaters. Although many books make passing reference to repeaters, only a few treat them with sufficient depth. Most importantly, I found that none of the books correctly explain the surprise-piece and some contain errors suggesting the text was copied from other works without much understanding. Also, none of the books go into sufficient detail to elucidate some of Crespe's points adequately.

Despite these difficulties, Crespe's text makes sense if enough effort is put into reading it. If we remember that it was written for competent workmen familiar with repeater mechanisms, then we will see that much of the problem lies in teasing out the meaning of what Crespe *omits* in order to understand what he wrote.

As with my previous translations I have attempted to produce reasonably good and intelligible English, rather than a literal translation. However, there are a small number of sentences in which Crespe's French made little sense in context and which I could not interpret confidently; these I have translated as best I can.

To assist the modern reader I have done three things:

Essay on Repeater Watches

- (a) I have added an illustrated description of a verge repeater. This defines the terminology I use and explains the action of quarter and half-quarter repeater-work. Where it is useful I have inserted references to this description in Crespe's text.
- (b) I have changed Crespe's definitions by including some explanatory notes and new definitions. The definitions are still in order of the French terms.
- (c) I have liberally inserted comments in footnotes.

References

Crespe assumes the reader is an experienced watchmaker; that is, someone who is familiar with and can make by hand a watch with a verge escapement. Consequently I recommend as background reading:

Ferdinand Berthoud and Jacob Auch: *How to make a verge watch*, 2004.

Another very useful book is:

Leonard Weiss: *Watchmaking in England 1760-1820*.

There are a number of books which describe the verge repeater or discuss its repair. The books which cover it that I have found useful are:

Baillie, GH: *Watches - their history, decoration and mechanism*, London, 1979.

This has a good, well illustrated description and is the only book that clearly shows the principle of the all-or-nothing piece detent. It also contains a good description of an alarm mechanism, but there is no illustration.

Berthoud, Ferdinand: *Essai sur l'horlogerie*, Paris, 1786.

This is probably the most well-known because some of the illustrations and/or text have been reproduced in many other books, including:

Booth, Mary L: *New and complete clock and watchmakers' manual*, New York, 1860.

Diderot and d'Alambert: *Encyclopédie ou dictionnaire raisonné des sciences, des arts et des métiers - horlogerie*, Paris, ca 1765. There is an English translation of the text accompanying the plates which includes the description taken from Berthoud's book.

Moinet, Louis: *Nouveau traite general, elementaire, pratique et theorique d'horlogerie*, Paris, ca 1853.

Reid, Thomas: *A treatise on clock and watch making, theoretical and practical*, London, 1826.

Berthoud only describes repeater-work. The translations in Booth and Reid leave a lot to be desired.

Hillmann, B: *La reparation des montres compliquées*, Vichy, nd; 4th edition.

An edition of this has been translated in:

Seibel, E; Hagans, OR: *Complicated watches*, Colorado, nd (first published 1945). I found the translation to be just fair, but the illustrations are excellent.

Lecoultré, Francois: *A guide to complicated watches*, Neuchatel, 1985.

Very good, if at times obscure. This book is the best examination of complicated watches that I have read.

Rees, Abraham: *The cyclopaedia or universal dictionary of arts, sciences, and literature*, London, 1802 to 1820.

The horology sections are, I believe, the outstanding survey of 18th century horology. They have been reprinted in Rees, Abraham: *Clocks, watches and chronometers*, London, 1970.

The following books do not cover the verge repeater in a useful way:

de Carle, D: *Complicated watches and their repair*, USA, 1977.

This only considers modern repeaters.

Etchells, CT: *Repairing repeating watches*, Chicago, 1917.

A small pamphlet for the repairer which is not all that intelligible.

Lepaute, Jean Andre: *Traite d'horlogerie contenant tout ce que est necessaire pour bien connaitre et pour regler les pendules et les montres*, Bologna, 1980 (first published 1755).

This has not been translated. It contains only a few pages with one illustration and seems a bit superficial.

Persegol, JE: *Nouvelle manuel complet de l'horloger rhabilleur*, Paris, 1895.

This has not been translated.

Reymondin, CA; Monnier, G; Jeanneret, D; Pelaratti, U: *The theory of horology*, Neuchatel, 1999.

This only considers modern repeaters and is far too superficial.

Thiout, Antoine: *Traite de l'horlogerie mecanique et pratique*, Paris, 1741.

This has not been translated. It is too early and the illustrations are inadequate.

Action of a verge repeater

Continuous motion and discrete states

Watchmakers expend much effort on devising ways to change continuous motion into discrete steps. Escapements are the obvious example and the repeater is another, where the repeater mechanism converts the continuous motion of the hands into a number of discrete movements of the hammers. A more common and less difficult example is a calendar mechanism for displaying dates. In all such cases we attempt to build a *state mechanism* that accurately recognises certain states of the machine and then performs some action unique to that state.

Not that watchmakers ever thought about such things; they were just trying to find practical solutions to problems. But for us, looking back, it is useful to understand the conceptual basis for their inventions.

A machine moving continuously can be in any of an infinite number of different positions, albeit for an extremely small time; and so there is no clear, distinct division between two positions. There is not an instantaneous transition but a *movement* from one state to the next, and the boundary between them is blurred by mechanical realities; such as the accuracy with which parts are made, necessary play in bearings and wear over time. In addition, any state mechanism we construct, to perform some action in response to a state, must take time to complete its task. But during this time the machine or watch continues to run and may move past the point which represented that state and onto the next state. Consequently the state mechanism, while it is performing its task, cannot interfere with the machine; any interference may affect the way the machine runs or even stop it completely. The reverse is also true and the machine should not interfere with the state mechanism; which is another way of expressing the problems with verge and other frictional escapements.

In many cases the state mechanism is totally under the control of the machine and its activation at state transitions is automatic; the striking mechanism in clocks is the obvious example. The mechanic is then in full control and can design the machine and its state mechanism to function correctly.

However, in a few instances a state mechanism can be activated at the whim of a human, arbitrarily and at any time. Because the mechanic cannot control its activation he must design a state mechanism which not only behaves correctly but which cannot be put out of order or synchronisation. Count wheel striking fails in this regard because it is easy to set its striking out of synchronisation with the hands.

The quarter repeater is one of the most sophisticated and complex examples of such a state mechanism. In it, a hand-made mechanism subject to play and wear must somehow unambiguously distinguish between radically different states which are separated by seconds. The most critical state change is the transition from 12 hours 59 minutes 59 seconds to 1 hour when, in an instant, the mechanism must change from striking 18 times to striking just once.

The purpose of this introduction is to explain how the quarter repeater mechanism works and, most importantly, to examine how it successfully converts the continuous motion of the movement into the correct, discrete states which we hear. Once we fully understand the quarter repeater, other repeater mechanisms are fairly easy to comprehend.

Terminology

The terminology for quarter repeaters, which is used throughout this book, is given in the tables preceding the figures. The tables give the part name, in which of figures 1 to 10 it will be found, and the symbol for the part used in those figures. The first table is in order of part names and the second in order of their symbols on the diagrams.

Note that Figures 1, 2 and 3 show the repeater-work from the dial side. In particular, Figure 3 is a view through the dial plate and so the positions and the directions of movement of the parts is the same as in the other two illustrations.

The design described here is the standard repeater mechanism used in nearly all early Swiss and French repeaters.

The basics - the repeater-train

The action of repeater-work is quite simple until we consider the problem of ensuring correct striking. All that is involved is a mechanism to cause two hammers to strike and to regulate their speed. I shall begin by describing only the parts which do this and leave the complications until later.

Pressing on the *push-piece*, Figures 1, 2, 7: *A*, causes the *winding-rack* *B-C-D* to swivel around its pivot-point *B* and pull the *chain* *e*, which winds the *repeater spring* under the pulley *z*; the only function of the *fixed pulley* *E* is to make this movement act in the right direction. The repeater spring is mounted in a fixed barrel screwed to the inside of the pillar plate, Figure 4. Its arbor has the *chain pulley* *z* and the *quarter-rack gathering-pallet* *r* squared onto one end, and the *click work* and *first wheel* of the repeater-train on the other end. The click work allows the spring to be wound without affecting the repeater-train or other parts.

Pressing on the push-piece winds the repeater spring less than one turn and so the chain pulley only needs a single groove.

When pressure is released the spring runs down, pulling the push-piece back up and driving the *repeater-train*, Figure 3: *s*. This train simply regulates the speed of unwinding. It ends with the *delay t*, a pinion mounted in an eccentric bush so that its depth with the previous wheel can be altered. By varying the depth the friction on the train can be altered and its speed controlled (Figure 8). Later repeaters use an escapement or a centrifugal fly instead of the delay.

The *hour-rack*, Figure 3: *G*, is attached to the first wheel. Before pressing the push-piece, the part without teeth is opposite the *hour-pallet*, Figure 3: *3-4*. Pressing the push-piece rotates the hour-rack anti-clockwise until some of its teeth move past the hour-pallet. As the train runs down the teeth of hour-rack, rotating clockwise, trip the hour-pallet *3-4* causing the *large-hammer*, Figure 3: *R*, to rise and drop, so striking the hours. (The pallet will be described later.)

Also squared onto the repeater spring arbor is the *quarter-rack gathering-pallet*, Figures 1, 2, 7: *r*. As the train runs down this moves the *quarter-rack L-M-N* by its *driving-pin k*. The quarter-rack has two sets of teeth, *N* and *L*, which trip the *quarter-pallets O* and *Q*, causing both the large-hammer *R* and the small-hammer *P* to rise and drop, so striking the quarters.

The order of striking

The hour-rack *G* causes the hours to strike before the quarters. It is a ratchet with 24 teeth, but 12 are removed so that half of it has no teeth and cannot trip the hour-pallet.

When the repeater is at rest, before the push-piece is pressed (Figure 1), the blank (toothless) half of the hour-rack is opposite the hour-pallet *3-4* and the quarter-rack is held away from the quarter-pallets. Activating, by pressing the push-piece, rotates the hour-rack anti-clockwise so that its blank half and then some of its teeth move past the hour-pallet. At the same time the quarter-rack gathering-pallet *r* rotates away from the quarter-rack, which drops because of the pressure of the *quarter-rack drop-spring* Figures 1, 2, 7: *f*, and some of its teeth move past the quarter-pallets.

When the push-piece is released and the repeater spring runs down (Figure 2), the hour-rack trips the hour-pallet some number of times. Then the hour-rack continues rotating, without touching the hour-pallet, until it returns to its rest position.

At the same time, the quarter-rack gathering-pallet *r* rotates, doing nothing at all during the time the hours strike. But then it meets the *quarter-rack driving-pin*, Figure 1, 2, 7: *k*, and moves the quarter-rack back, tripping the quarter-pallets and causing the quarters to strike on both hammers.

The quarter-rack teeth, Figures 1, 2, 7: *L* and *N*, are cut so that one set of teeth lifts and releases its hammer a fraction of a second after the other hammer, producing the double strike for the quarters.

Counting the hours and quarters

The hour and quarter-racks simply strike the hammers an arbitrary number of times and we need a mechanism to control the number of strikes.

The *quarter-snail*, Figures 1, 2, 5, 7: *S*, is rigidly fixed to the canon pinion and rotates once per hour. It has 4 steps corresponding to the 4 quarters. Provided the minute hand is correctly aligned with the quarter-snail, the quarter-snail will indicate the quarter on the dial in which the minute hand lies.

The *hour-snail*, Figures 1, 2, 5, 7: *F*, is mounted beside the quarter-snail. It is free to rotate, but the *star-wheel H*, and *star wheel jumper b*, hold it in one of 12 positions. The hour-snail has 12 steps corresponding to the 12 hours and the star-wheel has 12 *rays*. Each time the quarter-snail revolves, a pin on it moves the star-wheel forward one ray, or one twelfth of a rotation. So the hour-snail also rotates one twelfth to the next step on it, for the next hour. (Actually the process is more complicated as we will see later, but the effect is the same.) Provided the hour-snail and hour hand are correctly aligned, the hour-snail will indicate the hour on the dial in which the hour hand lies.

Note that the *only connection* between the going-train of the watch and the repeater mechanism is the quarter-snail fixed on the canon pinion; except for this the going-train and the repeater mechanism are completely independent.

The *winding-rack hour-snail arm Ca* limits how far the winding-rack can move when the push-piece is depressed, by contacting a step on the hour-snail *F*. As a result, it also limits how far the chain moves and how far the repeater spring arbor and the attached hour-rack rotate. If the arm contacts the lowest (twelve hour) step on the snail, the chain and the arbor move further than if it contacts the highest (one hour) step. If the arm contacts the highest step on the snail, the hour-rack rotates so that the blank part and only one tooth pass the hour-pallet. If the arm contacts the lowest (twelve hour) step, the hour-rack rotates so that the blank part and all twelve teeth pass the hour-pallet. On releasing the push-piece, between one and twelve hours will strike, depending on the position of the hour-snail.

Clearly the length of the chain *e* and the depths of the hour-snail steps control how far the hour-rack rotates and they must be exactly right; if not, fewer or too many teeth will go past the hour-pallet and the wrong hour will strike.

Likewise the *quarter-rack quarter-snail arm*, Figures 1, 5, 7: *c*, limits how far the quarter-rack can move. When the push-piece is depressed the quarter-rack drops because of the pressure of its spring *f*. How far it drops, and hence how many of its teeth pass the quarter-pallets, depends on the step of the quarter-snail that this arm meets. No teeth will pass with the highest step and all three teeth will pass with the lowest step. After the hours have been struck by the hour-rack, the quarter-rack gathering-pallet continues to rotate with the repeater spring arbor and, after a little time, it reaches the quarter-rack driving-pin *k*. It then forces the rack to return, tripping the quarter-pallets the correct number of times for the quarter.

Of course, the depths of the quarter-snail steps must be just right to ensure that the correct number of teeth pass the pallets.

Operating the hammers

First, consider the small-hammer *P*, Figure 3, and its quarter-pallet *O*, Figures 1, 2 and 7. This hammer is only used to strike the quarters.

The small-hammer *P* has a pin *y*, the *small-hammer quarter-pallet lifting pin*, between its arbor and its head, which protrudes through a slot in the pillar plate. The pallet *O* sits loose on the hammer arbor, which also extends above the plate, and this pallet has two arms, one meshing with the quarter-rack teeth *N* and the other on the outside of pin *y*.

When the push-piece is depressed the quarter-rack rotates anti-clockwise and its teeth slip past the loose pallet. During striking the quarter-rack rotates clockwise and each tooth moves the pallet anti-clockwise until it suddenly escapes. At the same time the other arm of the pallet moves the small-hammer quarter-pallet lifting-pin *y*, lifting the hammer and tensioning the *small-hammer strike-spring h*. When the pallet escapes the hammer drops and strikes the gong or bell.

The *small-hammer counter-spring i*, which can be adjusted by the screw on the outside near IX, controls the hammer's movement so that it hits the bell or gong and then rebounds to produce a single, clear sound.

Note that the quarter-pallet *O* must be able to move out of the way when the quarter-rack drops, rotating anti-clockwise. But if it stayed in that position it would not be moved by the teeth when the quarter-rack returns and there would be no striking. To ensure the small-hammer quarter-pallet will normally stay in mesh with the teeth, the *quarter-pallet return spring g*, holds the pallet in the correct position.

The large-hammer Figure 3: *R* strikes both the quarters and the hours and has two separate pallets, one for quarter striking and one for hour striking. As well as the hammer arbor *6*, there are three pins, Figure 3, 5, 7: *1*, *2* and *3*, which protrude above the plate. Pins *1* and *3* are visible in Figures 1 and 2, but pin *2* is hidden under the spring *q*. Pins *1* and *2* are attached to the large-hammer and pin *3* is attached to the hour-pallet. Figure 7 gives a good view of the hammer, the hour pallet and these three pins.

Quarter striking is the same as for the small-hammer, except that separate pins are used for lifting the hammer and for striking. The *quarter-pallet for the large-hammer*, Figure 5: *Q-5*, sits loose on the hammer arbor above the plate. Only arm *Q* is visible in Figures 1 and 2 because the spring *q* passes over arm *5*, which is why this pallet is on two levels, as shown in Figure 5 (and why one drawing of the pallet in the original Figure 5 was wrong). Both arms are visible in Figure 7 because that repeater uses a different arrangement for the springs.

The *large-hammer quarter-pallet lifting-pin* Figures 3, 5: *2* (hidden under the spring *q*) is engaged by arm *5* of the quarter-pallet *Q* (Figure 5) and lifts the hammer. The *large-hammer strike-pin*, Figures 2, 3, 5: *1*, only serves the function of striking for both hours and quarters, and it sits between the *large-hammer strike-spring p* and the *large-hammer counter-spring o*.

In Figures 1 and 2 there appears to be no quarter-pallet return spring for the large-hammer, corresponding to *g* for the small-hammer, but it must exist for the same reason. However, in this watch the spring *q* performs this function as well as another. It is slit so that two separate leaves came from a single head, one acting as the quarter-pallet return spring and the other acting as the hour-pallet return spring. In contrast, the movement shown in Figure 7 has a separate *large-hammer quarter-pallet return spring 9*.¹

Describing hour striking is complicated by a few errors in the illustrations from Rees; it seems the creator of the drawings did not look carefully at the hour striking.

The *hour-pallet*, Figures 3, 5: *3-4*, is also loose on the hammer arbor and meshes with the hour-rack. Because the pallet sits above the hammer, the *hour-pallet lifting pin*, pin *3* on the pallet *3-4*, extends below the pallet, as shown in Figure 6a (and as described by LeCoultre in *A guide to complicated watches*). This extension lifts the hammer when the pallet is moved by the hour-rack. In contrast, Figure 7 has an alternative arrangement where the pallet is under the hammer.

As with the quarter pallets, it is necessary that the hour-pallet can move out of mesh with the hour-rack when the repeater is wound by depressing the push piece, but it must return into mesh for striking.

¹ Another example of two springs coming from the one head is shown by springs *g* and *f* in Figure 7.

In Figures 1 and 2, the double function spring q acts as the *hour-pallet return spring*. It presses lightly on pin 3 to ensure the pallet returns after having been pushed aside by the hour-rack during winding. The repeater in Figure 7 uses two separate return springs. Spring 9 is the quarter-pallet return spring. The hour-pallet return spring is not shown, but it is inside the movement frame and acts on the *hour-pallet return arm 16*.

As noted above, all three of the pins, 1, 2 and 3, protrude above the plate. Pin 2 meshes with the quarter-pallet, pin 1 is held between the strike and counter-springs, and pin 3 is used by the return spring. However, pin 3 protrudes through the plate in Figure 7, even though it is not used for a return spring. This is because pin 3 must extend above the plate for another, very important function which will be explained shortly.

Simple but useless!

If that were all, quarter repeaters would be quite simple. However, such a mechanism has a number of defects which can cause it to strike the wrong number of times or even come to a halt. There are five distinct problems:

- (a) If the push-piece is depressed a little and released, then the wrong number of quarters can be struck.

As soon as the push piece is pressed, the quarter-rack gathering-pallet moves away from the quarter-rack driving pin, the quarter-rack can drop, and some teeth can move past the quarter pallets (up to the number allowed by the quarter-snail). When pressure is released these quarters strike. If the push piece is only depressed a small amount, so that the quarter-rack quarter-snail arm does not reach the quarter-snail, then no hours and too few quarters will strike.²

So, there must be a mechanism to prevent quarter striking unless the quarter-rack drops onto the quarter-snail.

- (b) If the push-piece is depressed further, but not far enough, and then released, the wrong number of hours will be struck.

Hour counting depends on the hour-rack rotating as far as it can, according to the position of the hour-snail. If it does not rotate far enough, too few hours will be struck unless there is some mechanism to prevent this happening.

Problems (a) and (b) need to be considered together. What is needed is some way to prevent *all* striking when the push piece is not depressed far enough. That is, there should be no striking at all until both the winding rack arm Ca and the quarter-rack arm c have reached the hour-snail and quarter-snail respectively.

- (c) If we activate the repeater just before I, the winding-rack hour-snail arm Ca will fall into the deepest step of the snail for XII. But at the same time the hour-snail is being pushed around by the quarter-snail (which is being continuously driven by the going-train) and the arm will be pressed against the side of the step for I. Then the quarter-snail, unable to move the hour-snail, will be stopped, causing the hands to stop moving or the watch to stop completely, depending on how tight the canon pinion is on the center arbor.

- (d) Exactly the same problem occurs with the quarter-snail as with the hour-snail. If the quarter-rack quarter-snail arm c falls into the three quarter step just before the hour it could be jammed against the side of the step and produce the same effects, causing the hands to stop moving or stopping the watch completely.

- (e) Any machine has to have some play in its moving parts and this freedom increases over time with wear. Assume the hands are at 10:59:50, just before the hour on the dial, and the repeater is activated. Will the winding-rack arm Ca fall on the X step of the hour-snail or the XI step? That is, if the arm is very near to the edge of an hour-snail step, will it sit on the step or will the play allow it to drop down to the next step? This is a matter of accuracy, but it is very important, because 11:45 could sound at 10:59 if the wrong step of the snail is used.

The same problem of play and inaccuracy occurs with the quarter-snail. That is, the quarter-rack could drop onto the three-quarter step at the hour and three quarters could strike instead of none.

The repeater mechanism, as I have described it, is quite useless, and each of these problems requires adding some clever and subtle complications.

The *all-or-nothing piece* solves problem (a) by holding the quarter-rack away from the snail unless the push-piece is depressed as far as it will go.

The quarter-rack and the *hour-pallet large-hammer lifting pin* solve problem (b) by preventing the hours from being struck unless the push-piece is depressed as far as it will go.

2 There will be no hours because if the hour-rack rotates far enough to strike even one hour, then the quarter-rack gathering-pallet must have rotated far enough to allow the quarter-rack to drop onto the quarter-snail and strike the correct number of quarters.

The *star wheel and its jumper* solve problem (c) by ensuring that arm a of the winding-rack cannot jam against the hour-snail.

The *surprise-piece* resolves problem (d) by preventing the quarter-rack arm c from jamming against the quarter-snail.

And finally, the star-wheel and jumper, and the surprise piece, resolve any problems with play.

The all-or-nothing piece

To solve the first problem, the quarter-rack is locked so that it cannot drop unless the push piece is depressed far enough. When the gathering pallet moves away from the quarter-rack driving pin, the quarter-rack will not move until the position of the push piece allows it to drop. The quarter-rack could be unlocked as soon as the gathering pallet has moved far enough to allow quarter-rack to drop onto the quarter-snail, when the correct quarter will be struck. But because the winding-rack arm Ca does not reach the hour-snail until after this, the hour striking can be wrong. So the quarter-rack should only be unlocked when the winding-rack hour-snail arm Ca reaches the hour-snail to ensure both the hours and the quarters strike correctly.

The quarter-rack is always trying to rotate counter clockwise and drop onto the quarter-snail because of the pressure of its spring f . The *all-or-nothing piece*, Figure 1: $I-K$, acts as a detent at K , locking the quarter-rack so that it cannot drop. So that the quarter-rack can drop when required, the all-or-nothing piece pivots at I and can move away to release the detent. The *all-or-nothing piece return-spring* J is kept in tension by a stud at w , attached to the plate. This spring presses the all-or-nothing piece towards the center and maintains the lock on the quarter-rack. By doing so it prevents quarter-rack dropping unless the all-or-nothing piece is pushed outward, releasing the quarter-rack.

Now, the only way we can tell if the push-piece has been depressed properly is if arm Ca touches the hour-snail. If it does not, the push-piece has not moved far enough, as in problem (b), and the quarter-rack should not be released.

The method for unlocking the quarter-rack is crude but ingenious. The all-or-nothing piece pivots at I , but it has another pivot at j , the *all-or-nothing piece star-wheel pivot*. The corresponding hole for the star-wheel and hour-snail pivot in the plate has sufficient play for the star-wheel and hour-snail to move a little *sideways*. This play is just enough for the all-or-nothing piece to turn on its true pivot I and so move the detent K away from the locking-face of the quarter-rack, allowing it to drop. Of course, the movement must be very small, to avoid breaking or bending the star-wheel pivots, and the *all-or-nothing piece spring-post* at w for the return-spring J acts as a banking pin. This spring-post can be seen in Figure 2, inside the hole w against which it banks.³

Thus, the quarter-rack can only be unlocked if the winding-rack hour-snail arm Ca pushes hard enough against the hour-snail to move the snail, star-wheel and all-or-nothing piece sideways. Which is just what we want, because this can only happen if the winding-rack is pressed down far enough to produce correct striking.

As we have already seen, when striking takes place the quarter-rack is pushed outwards again, against the pressure of spring f , by the quarter-rack gathering-pallet r . At the same time arm Ca of the winding-rack has moved away from the star wheel pivot j and the all-or-nothing piece returns to its original position under the pressure of spring J . Eventually the gathering-pallet will move the quarter-rack back to its original position, it will push the all-or-nothing piece aside and once again it will be locked by the detent K .

The hour-pallet large-hammer lifting pin

Problem (b) is a separate issue. Irrespective of the behaviour of quarter-rack, the incorrect number of hours will be struck if the push-piece is not depressed far enough. The hour-rack will rotate, but not enough of its teeth will pass the hour-pallet, and on its return the hour-pallet will lift and drop the large hammer too few times. To overcome this we need a mechanism which will allow the push-piece, chain, repeater spring and hour-rack to return to rest without any striking. This can only be done if the hour-pallet is held away from the hour-rack, for then the repeater-train can unwind silently.

Having solved problem (a) there are two pieces which indicate that the push-piece has been depressed far enough; the arm Ca touching the hour-snail and the quarter-rack dropping. One of these must somehow control the position of the hour-pallet.

Hour striking is prevented by pin 3 of the hour-pallet. When the quarter-rack is locked, the *quarter-rack locking-face*, Figures 1, 2, 6: m , holds the *hour-pallet large-hammer lifting pin* 3 so that the hour-pallet is swung out of mesh with the hour-rack. When the quarter-rack drops, the hour-pallet large-hammer lifting pin is released and the *hour-pallet return spring* q pushes the pallet into mesh with the hour-rack.

So when the repeater is at rest, the all-or-nothing piece locks the quarter-rack which, in turn, keeps the hour-pallet out of mesh. Any inadequate pressure on the push-piece will wind the repeater spring

³ Crespe describes a more sensible arrangement, but I am only concerned with the principles here.

which will then run down without any striking at all.⁴

If we unlock the all-or-nothing piece detent, the quarter-rack drops and the hour-pallet is freed, which can only happen if the push-piece is fully depressed. Then the repeater will strike the correct hours and quarters. But as soon as it finishes striking, the quarter-rack gathering-pallet will raise the quarter-rack so that it is again locked by the all-or-nothing piece and the hour-pallet is again made inoperative by the quarter-rack locking-face *m*.

Thus pin 3 performs two or three functions. First, its basic role is to lift the large-hammer for striking, which is why it is called the hour-pallet large-hammer lifting pin. Second, in conjunction with the quarter-rack locking face, it keeps the hour-pallet out of mesh with the hour-rack until the quarter rack drops to allow striking. And third, in some repeaters it is used by the hour-pallet return spring to keep the hour-pallet in mesh with the hour-rack during striking.

The all-or-nothing piece gets its name from the fact that it ensures correct striking or no striking at all, directly controlling quarter striking and indirectly controlling hour striking.

The star-wheel and jumper

The third problem, of the winding-rack hour-snail arm *Ca* jamming, is the reason for having the star-wheel. At the same time the star-wheel overcomes any problem with play or inaccuracy which might cause the hour-snail arm to drop onto the wrong step.

The hour-snail, unlike the hour hand, is not geared to the canon pinion and is perfectly free to rotate.⁵ The star-wheel *H* and its jumper *b* are used to hold the hour-snail in position so that it presents the correct hour step to the winding-rack. The jumper-spring *d* is very weak and the star-wheel and snail will rotate very easily, but if they are moved only a small amount the jumper will return them to their correct position.⁶

This is the situation at all times except when the hour is to be changed. As mentioned above, the hour is changed by a pin on the quarter-snail which turns the star-wheel. (As I have noted, this is a simplification. The true situation, explained below, is more complicated, but the effect is the same.) When the pin rotates the star-wheel, the jumper rises up a ray until it reaches the point, and then it suddenly drops down the other side pulling the star-wheel and hour-snail around quickly so that the hour-snail is correctly positioned for the next hour.

To understand the behaviour of the snails we need to use angles. In one hour the minute hand rotates through 360°, and so the minute hand rotates through 6° in one minute. The hour hand rotates through 360° in 12 hours, and so it moves 30° in one hour.

Consequently, each step of the hour-snail must cover 30° and the 12 rays of the star wheel must also cover 30°. As there are 12 rays and the pin on the quarter-snail acts only to move a ray half its width, the minute hand needs to move about 15°, which is one twenty-fourth of an hour or 2½ minutes, to change the hour. That is, when the minute hand is at 57½ minutes the star-wheel and hour-snail start moving, and when the minute hand is at 60 they rapidly jump to the next hour.

As shown in Figures 2 and 11a, the hour-snail is positioned so that arm *Ca* of the winding-rack normally meets it close to the leading end of a step, with a small gap to ensure it cannot meet the end of the step for the previous hour. But when the jumper reaches the point of the next ray, the arm meets the step in the middle, Figure 11b. This means that during the 2½ minutes the correct hour step is presented to arm *Ca* and it is only during the very brief moment when the jumper pulls the snail the rest of the way that the arm can fall on either step. Consequently, except at the instant when the hour-snail jumps, which should happen when the minute hand is exactly on XII, the correct hour must be registered. It also means that the width of arm *Ca* must be *at most* half that of the narrowest step, 15° or less. So a small inaccuracy or some play cannot cause wrong striking.⁷

Now we can look at the 1 o'clock problem. But first, note that arm *Ca* is only in contact with the hour-snail while the push-piece is being pressed. As soon as the push-piece is released, the repeater-train runs and arm *Ca* is drawn away from the snail. Because the hour-snail is completely detached from the going-train, except just before the hour, continued pressure on the push-piece will have no effect on anything.

4 Rees has incorrectly drawn the spring *q* in Figures 1 and 2, and has shown pin 3 in the wrong position in Figure 2; I have altered both figures so that they are closer to the truth. Spring *q* (shown correctly in Figure 6b) has an extension which rests against pin 3. In Figure 1, pin 3 should be sandwiched between *q* and arm *m* of the quarter-rack, as in the cover photograph. In Figure 2, pin 3 should be roughly in the position shown in Figure 6b.

5 Some early repeaters did have the hour-snail geared to the canon pinion; Rees describes one design by the Englishman Stockten (or Stogden). This system was complicated and unsatisfactory.

6 When a repeater is assembled, the star-wheel and hour-snail can easily be turned by hand so that the hours strike correctly or incorrectly (when every hour struck will be out by the same number of hours).

7 It should also be noted that the position of the hour snail relative to arm *Ca* can be adjusted by moving the jumper slightly. So, provided the snail is cut accurately, it is easy to ensure the correct step will always be used.

(Just before the hour, when the pin is moving the star-wheel, continued pressure for several seconds may prevent the quarter-snail turning and so prevent the canon pinion turning; which will either cause the canon pinion to slip or the watch to stop.⁸)

More importantly, at every hour change except from XII to I the next step on the hour-snail is deeper. Consequently as arm Ca rises away from the snail they cannot touch each other. However, just before 1 o'clock, arm Ca will enter the deepest step, that for XII. In this case the side of the step can press against the arm as the arm rises and the hour-snail rotates towards I, Figure 11d.

Let us assume it takes about a second to strike the hour once. Then (as one strike occurs when Ca is outside the hour-snail) it will take about 11 seconds for a to rise from the bottom of the XII step, and in this time the canon pinion will rotate a little more than 1° (1 minute occupies 6° and so 10 seconds, one sixth of a minute, occupies 1°). So, if there is a gap a little greater than 1° between Ca and the side of the step then:

- (a) The jumper will drop down the side of the ray, moving the hour-snail forward and pressing it against arm Ca .
- (b) There is then a gap of 1° between the star-wheel and the driving-pin on the quarter-snail, so that it will be about 10 seconds before the pin reaches the ray and starts pushing it again.

With this small gap the star-wheel and hour-snail will be free and the only thing pressing the hour-snail against Ca is the very weak jumper-spring, which will cause little friction and will not jam Ca .

As mentioned above, the maximum width of arm Ca is half a step or 15° . If it is reduced to 13° the necessary gap between a and the side of step XII is achieved, allowing a to rise with minimal hindrance and with no chance of being jammed by the pressure of the going-train through the canon pinion.

Alternatively, we could make the rays of the star-wheel asymmetric and more like ratchet teeth. If the side which lifts the jumper is steeper and uses only 10° instead of 15° then 20° of the step will remain for arm a when the jumper reaches the point. If a is about 15° wide there will be 5° of freedom. Another alternative would be to slightly reduce step I, making step XII wider.⁹

The surprise-piece

The fourth problem is that of the quarter-rack quarter-snail arm c jamming, which is solved by the *surprise-piece*. In his book, Crespe's student asks "Please give me a description of the surprise-piece, which few horologists can explain?" It seems that nothing has changed in the last two hundred years and few, if any, twentieth century horologists can explain it. Perhaps this is because of the misleading name that it has been given. I presume "surprise-piece" comes from the surprising way it appears from under the quarter-snail rather than its function, which is odd as all other pieces are named for what they do. It should be called the *quarter-snail freedom piece*.¹⁰

Before examining the surprise piece, I will consider the related fifth problem (e) above.

Unlike the hour-snail, the quarter-snail is rigidly fixed to the canon pinion and is continuously driven by the going-train. Consequently, the quarter-rack arm c can drop precariously onto the very edge of a step. If this happened with arm Ca and the hour-snail it could be disastrous because a is pressed against the snail with considerable force and the edge of the step or arm a could be damaged (but this cannot happen because of the star-wheel, as we have seen). However, arm c drops lightly onto the quarter-snail under the pressure of the weak quarter-snail drop-spring f and damage is unlikely.

This situation is not important, except for just before and at the hour. As the quarter-snail is turning continuously, arm c will simply drop off the step into the next deeper one while the hours are striking and one more quarter will be struck; but as the minute hand has moved to the next quarter the striking will be correct. Alternatively, if c lands on the step a little further back it will simply stay on that step. Of course, if c lands on the hour step (the zero quarter step) it will simply stay there. The quarter-rack drop-spring f needs to be weak to minimise friction as the snail moves under c . Thus, other than just before the hour, a slight inaccuracy or play will not cause a recognisable error in striking and the fifth problem can be ignored.

However, just at the hour c might drop onto the $3/4$ step and arm Ca onto the step for the next hour. This could occur if the quarter-snail is not divided accurately or if there is some play, so that just as the

8 It is impossible to design a machine that is totally protected from human stupidity!

9 Lecoultrre is the only author to mention this problem; but he does so in passing, in relation to modern repeaters, and without any explanation. He gives a detailed description of how to make an hour-snail with the steps divided equally and goes on to say "the length of the highest step is reduced", illustrating the discussion with an hour-snail with step I about half its normal width and step XII $1\frac{1}{2}$ times its normal width, but he does not refer to it in the text. Reducing one step to 15° and increasing the other to 45° , giving 15° of freedom, is unnecessary and makes no sense to me; 5° is plenty.

10 A surprise-piece was used by Daniel Quare circa 1680; see J.H. Francis Wadsworth *A history of repeating watches*, Antiquarian Horology, 1966. But I haven't been able to find out anything about the origin of the term.

jumper forces the star-wheel round, the 3/4 step is still accessible; and consequently we may hear 2:45 at 2:00. The reverse, striking 1:00 at 1:59 is also possible. As we have seen play or inaccuracy in the other quarters can be ignored because it does not cause a recognisable error in striking.

But before this happens the quarter-rack will have jammed anyway! If the quarter-rack arm *c* drops onto the snail just before the hour the snail will continue to turn and *c* will jam up against the side of the 3/4 step. This will cause the canon pinion to slip or the going-train to stop. The problem is compounded by the fact that *c* rests on a step for a long time while the hours are struck. If there is a two second gap between hour and quarter striking and each strike takes one second, then up to 17 seconds must pass before *c* is completely withdrawn from the quarter-snail. And if *c* drops a fraction of a second before the hour, the canon pinion will be locked for this time. If striking is slower the canon pinion could be locked for 30 seconds or more.

There is no simple solution to this, to have correct quarter striking while enabling the quarter-rack arm *c* to *rise freely without touching the quarter-snail*. To create a gap for freedom we must increase the width of the 3/4 step by reducing the width of the hour step. But then *c* will drop into the 3/4 step *after* the hour and incorrect striking will occur! And it will still jam because of the continuous rotation, but it will jam when it drops a little later after the hour.

The authors I have read do not appear to be aware of this problem and Crespe's student would be just as bemused now as in 1800. Lecoultre, in *A guide to complicated watches*, says the surprise-piece is to "facilitate the *drop* of the arm on the lowest step at the moment when the minute hand indicates 59' 50". But the arm has no trouble *dropping*; the problem is when it rises up. The translation of Hillmann in Seibel and Hagan's *Complicated watches* says "a guard piece is snapped into position to stop all quarter striking, or rather to eliminate any possibility of a quarter strike". Which is true on or after the hour, but it ignores the real problem. A crude translation of Hillmann's *La reparation des montres compliques* (4th edition) reads "The goal of the surprise-piece is thus to make it possible to sound the three quarters immediately before the hour changes, and to remove any ringing of the quarters as soon as a new hour is prepared"; which is no better. Rees *The cyclopaedia or universal dictionary of arts, sciences, and literature* describes the surprise-piece but gives no explanation of its purpose. Reid's translation of Berthoud¹¹ in *A treatise on clock and watch making, theoretical and practical* says "the advance which the star-wheel teeth causes the surprise to make, serves to prevent the arm [of the quarter-rack] from falling into the step which would make the three quarters repeated when at the 60th minute". And Baillie in *Watches - their history, decoration and mechanism* says "It was found impractical to make the parts work together so accurately as to prevent this error".

All these explanations miss the point and none of them explain how the surprise-piece actually works and why it exists. They actually refer to the problem of incorrect striking at the hour. We must *deliberately provide freedom* and so *deliberately* allow *c* to drop onto the 3/4 step after the hour; the quarter-rack arm can only be free to rise if the 3/4 step is made over wide and the hour step made too narrow. Thus incorrect striking at the hour is actually an *inevitable necessity* and we must have a *mechanism to extend the hour step* just after the hour so that incorrect striking cannot occur.

Crespe did not miss this point, although he too is vague. He says quite explicitly, when dividing the quarter-snail, "at mid-day the pointer will have to be past the point by about a minute in order to leave time for the surprise-piece to change the hour". As we will see, the surprise-piece does move the star-wheel to change the hour, but its *main* function has always been to compensate for the necessary freedom between arm *c* and the quarter-snail.

The quarter-snail is cut unequally. The first and second quarter steps occupy 90°, but the third quarter is wider and the hour narrower. If we use Crespe's specification, the 3/4 step covers 96°, from 45 minutes to 1 minute past the hour, and the hour step covers 84°, from 1 to 15 minutes.¹² This provides the necessary freedom for 3 quarters to strike up to the hour without the quarter-rack arm jamming. But without the surprise-piece, three quarters will strike up to 1 minute after the hour (and the arm will still jam).

The *surprise-piece*, Figure 9: 7, is mounted loose on the canon pinion *10* under the quarter-snail *S*. It is free to rotate but its movement is limited by pin *11* on the quarter-snail, which runs in a slot in the surprise-piece. As the canon pinion rotates (anti-clockwise in Figure 9 because we are looking at it from underneath) it draws the surprise-piece around with it. The button, Figure 9: 8, meshes with the star-wheel and rotates it in the way I described earlier (but without mentioning the surprise-piece). Thus the surprise-piece rotates as one with the quarter-snail, but being loose it will flop about and its movement is only limited by pin *11* and the slot. Thus it can come out from under the quarter snail at any time and prevent the quarter-rack from dropping onto the step of the quarter-snail. For this reason all of the sur-

11 Ferdinand Berthoud, *Essai sur l'horlogerie*, 1763.

12 This can be seen in Figure 1: *S*. If a quarter-snail or hour-snail is cut regularly, a line from the edge of one step to the edge of the opposite step should pass through the center. Most books, including those by Berthoud, Hillmann and Lecoultre, show the quarter snail drawn with equal steps. These drawings used by "expert" writers are wrong.

prise-piece, except the part near the button 8, is smaller than the quarter-snail and it will only affect how far the quarter-rack drops on or after the hour.¹³

Figure 10 shows the position of the parts just before the hour. The canon pinion and quarter-snail (shown in outline) are rotating in the direction the arrow, pin 11 is turning the surprise-piece, button 8 is turning the star-wheel (and the hour-snail) and the star-wheel jumper *b* has almost reached the tip of the next ray to change the hour. At this time the surprise-piece is held back under the hour step of the quarter-snail by the ray being pushed and, if the quarter-rack drops, arm *c* will fall on the 3/4 step. Until the jumper reaches the tip of the ray there is sufficient freedom for the quarter-rack to drop onto and rise from the 3/4 step.

Exactly at the hour the jumper reaches the point of the star-wheel ray and drops down the other side, pushing the star-wheel around. The ray *behind* the surprise-piece button jumps forward and hits the button, pushing the surprise-piece forward to fill in the 3/4 step and form an extended hour step (as shown by the dotted lines marked with an asterisk); so the quarter-rack will fall on the enlarged hour step. At the same time, the ray *in front of* button 8 has jumped forward and pin 11 has moved to the other end of the surprise-piece slot. In this situation the quarter-snail and canon pinion are free to rotate (until pin 11 catches up to the surprise-piece) and the surprise-piece is only held in position by the weak force of the star wheel jumper-spring acting on the ray.

Let us assume it takes an excessively long 30 seconds to strike 12 hours and 3 quarters. Then:

- (a) At any time up to 12:59:30 the surprise-piece plays no part and 12:45 is struck normally, with sufficient freedom on the 3/4 step for the quarter-rack to rise even if the step had been cut only 90° wide.
- (b) At any time after 1:00:00 the surprise-piece ensures the quarter-rack falls on the extended hour step and, as the hour-snail has advanced, 1:00 is struck.
- (c) Between 12:59:30 and 12:59:59 the surprise-piece is held back under the hour step and the quarter-rack drops onto the 3/4 step while the hour-rack drops onto the 12 step. Again 12:45 will be struck correctly and the quarter-rack can rise without touching the quarter-snail because the 3/4 step has been cut wide enough. But during striking the canon pinion will rotate to 1:00:00, the star-wheel (and hour-snail) will jump forward and the surprise-piece will be pushed out to touch the quarter-rack arm. However, the surprise-piece is held only by the very light pressure of the jumper-spring. As the quarter-snail rotates, the surprise-piece will be slowly pushed under the hour step, held very lightly between the quarter-rack arm and the star-wheel ray.

Note that the surprise piece must have a button (or two pins) and not just a pin. If there was a single pin, then the ray of the star-wheel behind it would not be able to push the surprise piece out.

And finally, I must say this *quarter-snail freedom piece* is a very ingenious, very beautiful idea.

Hand setting

We now have a satisfactory, fully functional repeater mechanism. The only remaining point to notice is the problem caused by people who set a watch by turning the hands backward.

Turning the hands forward is exactly the same as normal running, only faster. However, by turning the hands backward the repeater mechanism may get deranged. In particular, because the hour-snail is free it may not regress to an earlier hour as the minute hand is turned past XII.

To ensure correct behaviour, the surprise-piece button *S* and the star-wheel jumper *d* must act symmetrically, both forward and backward. However, the surprise-piece button requires some freedom between the star rays and may not move the star back enough for it to regress the hour-snail. So the hands must only be set forwards near the hour, although they can be set backwards at other times. Of course, the hands must not be set while the repeater mechanism is active.

The half quarter repeater

There are two methods for half-quarters.

The simple method is to change the quarter-snail to have 8 steps and the quarter-rack to have 7 teeth; then the watch strikes the hour followed by 0 to 7 half-quarters. This method, described by Baillie and Moinet, has exactly the same mechanism as a quarter repeater, but the listener has to become proficient at interpreting the half-quarter sounds. This method is also used for 5 minute repeaters where the quarter-snail has 12 steps.

The method described by Crespe is more sophisticated and requires a more complicated mechanism. It uses a separate half-quarter-snail and a half-quarter-rack mounted on and linked to the quarter-rack so that, after the hours and quarters have struck, a single blow can be given for the half-quarter. Figure 12 (adapted from Lecoultré) shows a modern arrangement, but the principles of its action are the same

¹³ Because the surprise piece is loose, it will often be seen protruding from under the quarter-snail when its position is not being controlled by the button; as shown in the cover photograph. So there is simply no justification for calling it a surprise piece, unless because people could not understand how something that apparently flopped about uncontrollably could be useful!

as the mechanism that would be found in a verge repeater like the one shown in the other figures. In the following I shall be referring to Figure 12 and its different nomenclature.

The half-quarter-rack *A* pivots freely on the same axis *H* as the quarter-rack *B*. It has only one tooth which acts on the small-hammer. This tooth, depending on the snails, can stand free causing an extra strike, or be super-imposed over the last quarter-rack striking tooth and have no effect. The two racks are linked by the jumper-spring *D* mounted on the quarter-rack and acting on the pin 2 on the half-quarter-rack. This spring ensures the half-quarter-rack is held in one of two positions relative to the quarter-rack, with its tooth active or inactive (super-imposed over the last quarter-rack striking tooth).

The “at rest” positions of the two racks is when the two locking faces at *E* are aligned and resting against the large-hammer quarter-pallet; this is the same arrangement as shown in Figure 12a, but before the racks have dropped. In the “at rest” position the half-quarter tooth *C* is exposed and the end of the half-quarter rack snail arm is in advance of the quarter rack snail arm.

Both racks drop together under the action of the quarter-rack drop-spring *M* acting on the pin *I*, the half-quarter-rack dropping because of the linking spring *D*. What then happens depends on the position of the snails:

- (a) Figure 12a. A half-quarter is struck if the steps of both snails are at different heights, the half-quarter snail (shaded) being smaller. In this case the motion of both racks is arrested at the same time because the half-quarter rack snail arm is in advance of the quarter rack snail arm and both meet their respective snails simultaneously. Consequently, the fourth, half-quarter tooth remains exposed. The quarter-rack gathering piece *G* raises the quarter-rack, striking the quarters. The half-quarter-rack rotates with it and strikes a half quarter. The motion of the two racks is halted at the same moment because the quarter-rack hour-pallet locking-face and the half-quarter-rack stop at *E* are aligned.
- (b) Figure 12b. A full quarter is struck when the steps of both snails are at the same height. The half-quarter-rack arm, being in advance, is stopped by its snail while the quarter-rack continues to drop onto its snail. This extra movement causes spring *D* to slip to its other position and the fourth tooth is hidden above the third quarter-rack tooth. The quarter-rack gathering piece *G* raises the quarter-rack, striking the quarters. The half-quarter-rack rotates with it and no half quarter is struck. The motion of the half-quarter-rack is halted first because its stop is in advance of the quarter-rack hour-pallet locking-face. The quarter-rack continues to rotate until it is stopped, forcing spring *D* back to its original position and again exposing the half-quarter tooth.

A surprise (freedom) piece is necessary. Both the snails must have narrow full-hour steps to provide the freedom necessary so that the rack arms can rise up just before the hour without binding the canon pinion. (This is shown by the fine lines on Figure 12 which mark the quarter divisions.) A half-quarter repeater uses the same type of surprise piece as a quarter repeater except it has a raised lip outside the hour step which goes up to the level of the half-quarter snail; in Figure 12, *F* is the edge of this surprise piece.

Finally, screw *G* acting in a slot helps keep the two racks together. Its slot and the hole through which pin *I* acts limit the movement of the half-quarter-rack.

Alarm mechanisms

In addition to repeaters, Crespe discusses alarm mechanisms. The following sections describe alarms to assist with understanding Crespe's text. They are taken from standard horological texts.

Alarm with moving dial¹⁴

Alarm watches are machines arranged so that at a specified hour a hammer strikes a bell, and makes a noise able to wake up a person. This hammer is moved by a special small train driven by a mainspring similar to that of the movement, but which is smaller. When it is desired that the alarm strikes, the dial *A* (Figure 13a) is turned until the hour at which one wants to wake up comes under the pointer *E* of the hour hand (at 11 in Figure 13a); then the spring of the alarm is wound, and one lets the watch run. When the hour hand reaches, on the large dial, the hour marked by the hand on dial *A*, a detent which communicates with the dial releases the small train which turns and makes the hammer strike on the bell. There are various ways to make alarm watches, but that which is simplest, easiest to construct, and which (even when poorly made) is the most solid, is that of which I give a description, and which figure 13 represents.

In Figure 13b, *B* is the barrel of the movement; *A*, the fusee wheel; *F*, the fusee; *S*, the chain; *O*, the beak which stops against the chain-guard; *C*, the center wheel; *d*, the center wheel pinion; *D*, the third wheel; *E*, the contrate wheel; and *R* (Figure 13d) is the escape wheel. The wheels *C* and *R* (Figure 13c) are the motion-work wheels. These are the parts of an ordinary watch and it is not necessary to repeat their description here.

The wheel *G* (Figure 13b) is the first wheel of the alarm. It is carried on the arbor *m* on which the ratchet *N* is fixed, which operates the click-and-ratchet work carried by the wheel *G*.

The top plate (Figure 13d) sits on the pillar plate (Figure 13b) to form the frame in which the wheels are mounted. This plate (Figure 13d) thus put in position, the arbor *m* passes through the hole in the barrel *B*, so that its hook enters the interior eye of the spring of the alarm contained in the barrel. Thus when this arbor is wound up, the hook which it carries tightens the spring whose external end is attached to the outer edge of the barrel. When the spring unwinds the arbor *m* and the ratchet *N* rotate, the ratchet acting on the click carried by the wheel *G*, making *G* turn, as well as wheel *n* carried by the pinion *g* with which it meshes, and consequently also makes the pinion *f* turn. The wheel or ratchet *R* (Figure 13c), which is placed on the other side of the plate together with wheel *n*, is fixed on this pinion. The pivots of these two wheels turn in holes in the bridge *H*.

The teeth of the escapement ratchet *R* (Figure 13c) alternately operate the levers *a*, *b* which communicate the movement reciprocally by means of the pallets that these levers *a*, *b* carry. The lever *a* is fixed on the square of the prolonged pivot *p* of the alarm hammer *M* (Figure 13e)¹⁵; this hammer is mobile, pivoting at *I* (Figure 13b), and passes under the barrel *B* of the movement; the other lever *b* is mounted on a stud on the plate (Figure 13c). These two levers *a* and *b* being moved by the ratchet *R*, one sees that the hammer *M* (Figure 13b) will turn, going and coming alternately, on one side and other; and that if one places a sound body at *M* and *M*, such as a bell, this hammer will make it sound with a force related to the space through which the hammer moves, the mass of the hammer, the force of the engine or spring, and finally the size of the bell. Thus the noise which the alarm watch makes depends on these various things, and the way in which the force of the spring is communicated by the train, etc.

The piece *A* (Figure 13c) is squared on the prolonged pivot of the arbor *m* (Figure 13b); this square passes through the dial and is used to wind up the alarm. The piece *A* carries a tooth which is used to regulate the number of turns which one can wind the alarm spring. The small wheel *F* has 3 teeth which occupy only about half of the circumference. Thus, as one turns *A* its tooth will enter the spaces between the teeth of the wheel *F* in turn, until this wheel *F* presents the part where there are no teeth. Then the tooth on *A* will not be able to turn any further, and the alarm spring will be wound up. Finally when the spring unwinds, it turns only to the point where the tooth of *A* comes to rest on the edge of the wheel. This is the same as Geneva stop work.

The wheel *F* turns on a stud or screw carried by the plate: the spring or piece *G* presses on this wheel *F* so that it turns only with friction, when it is obliged to by the tooth of *A*. Now we will see how the train and the motor are restrained when the spring is wound up, and how the alarm sounds at an hour chosen at will.

The lever *b* (Figure 13c) carries the angular notch 1-2 which enters the point *d* formed on the arm of the detent *d-f-4*, mobile at *f*. The arm *f-4* rests on the disk *p* which is fixed on a canon which goes friction tight on that of the hour wheel *C*. This disk *p* thus makes one turn in 12 hours.

During all the time that the arm *f-4* presses on the edge of the disk *p*, the levers *a* and *b* are held by the point *d* of this detent and cannot turn nor let the hammer strike. The disk *p* has a notch *o* which, having

¹⁴ This section is an edited translation of chapter 11, part 1 of Ferdinand Berthoud: *Essai sur l'Horlogerie*, 1763.

¹⁵ For lever *b* to communicate with the hammer it has to be geared into *a* as shown.

arrived at the end 4 of the detent $d-f-4$, allows the arm $f-4$ to descend under the pressure of the spring g , as also the inclined plane of the angular notch $1-2$ tends to make it enter the notch o as soon as it is presented. At that moment the arm d moves away from the angular notch $1-2$ and it turns from one side to the other, according to the action of the ratchet R , and thus the hammer strikes the gong.

The dial A (Figure 13a) is divided into 12 parts: it is squared on the canon of the disk p (Figure 13c), which turns, have I said, with the hour wheel.

The notch o of the plate p is presented to the arm $4-f$ at the moment that the 12 hour mark of the small dial is on the six hour line of the large dial. Thus, each time dial A makes a turn, if the alarm is wound up, it sounds at the time that the figure 12 is on the six hour line. However, if in this position one puts the small pointer of the hour hand (the pointer diametrically opposed to the large pointer indicating the hour) on the figure 12 of dial A , the hour hand will mark midday on the large dial, while the 12 hour mark of the small dial will be diametrically opposite that of large dial; thus the alarm will sound at midday, since at this moment the notch o is presented to the arm $4-f$.

The alarm sounds, as has been shown, each time the figure 12 is at the six hour line of the large dial. Thus the hour at which the hammer will strike depends on the interval between the figure 12 of dial A and the pointer E of the hand; because it was seen that by putting the pointer E of the hand on figure 12, the alarm clock sounds when the hour hand arrives at midday. Thus, if one puts the figure 1 of dial A on the pointer E of the hand, that will retrogress the dial one hour; when the hour hand is over midday the point of the hand being on figure 1 of the dial, it is necessary that the hour hand traverses one hour on the large dial; for the figure 12 of dial A to be on the six hour line and the alarm to sound.

It is by similar reasoning that one will see that, by putting the figure 3 on the pointer E of the hour hand, when the hour hand arrives at midday, the alarm dial will present the figure 3 at the six hour line. It will thus be necessary that the hour hand and dial A traverse three more hours before the figure 12 arrives at the six hour line and the alarm strikes; thus this will happen when the hour hand arrives at three hours; and so on for all the other hours, etc.

In alarm watches with a dial, it is thus sufficient to put the figure which represents the hour at which one wants to be awoken under the pointer E of the hand; for when the hour hand arrives at the hour in question the alarm sounds.¹⁶

Arm x of the lever b (Figure 13c) is used to prevent the hammer M from approaching too near the bell; the fork P , which is a spring, brings back the hammer as soon as it has struck the bell; the spring h is the dial spring; 5 is a click which, with the ratchet D , takes the place of the endless screw, which is commonly fixed to the arbor of the mainspring of the movement, to set it up with the degree of tension which it is necessary. Spring 3 holds the click against the ratchet D .¹⁷

Alarm with fixed dial¹⁸

The part which constitutes the alarm is a ratchet A which drives a hammer with speed, see Figure 14. This ratchet is put in motion by a spring contained in a barrel which acts on the wheel C , which in turn acts on the second wheel B , and B meshes with the pinion of the ratchet.

When the ratchet is free, it alternatively operates the two levers D , E . The arbor of the lever D carries the hammer, which strikes the case alternately at F and G ; but in its ordinary state, when the alarm does not sound, the pallet E is locked by a pin at f , placed perpendicularly on the end of the detent $f-g$.

The detent $f-g$, is mobile around an axis $L-I$, so that when its end g has the freedom to drop, the spring $M-K$, which always presses upwards, raises the part f , which disengages the pin from the pallet.

All that remains is to work out how this part g of the detent has the freedom to drop at the hour when the alarm must sound, and why all the rest of the time it is raised, in spite of the spring $M-K$ which tends to lower it. For this one must realise that the dial wheel is below the part g of the detent, and that it is fixed to the hour wheel. The hand of the alarm $N-O$ has a notch N and is placed under the hour hand. When the pin P on the hour hand meets this notch it enters it¹⁹. Then the spring $M-K$ has freedom for g to make the dial wheel drop and so release the pin f , because the detent $f-g$ turns on the axis $I-L$.

The stopwork m is useful to control the number of revolutions which can be made by the spring contained in the barrel when winding up the alarm. When one winds the alarm, the pallet n fixed on the

16 Of course the alarm can sound at any time by positioning the dial A between hour markers, but setting is not very accurate.

17 The piece G (Figure 13d) is not explained. It is a silencer. It can be held in so that one end rests against the detent arm $d f$ preventing the end 4 from dropping into the notch o .

18 This section is an edited translation of chapter 5 of Jean Andre Lepaute: *Traite d'horlogerie*, 1767.

19 There is no need for a separate dial wheel (which must be rigidly fixed to the hour wheel) and g can rest on the hour wheel. The alarm hand is mounted on the dial (and not on the dial wheel or the hour wheel) and is turned to the awake hour marked on the fixed alarm sub-dial. Once every hour the pin on the hour hand drops into the alarm hand notch and the hour wheel drops with it. The notch has a one side inclined so that the hour hand (and hour wheel) can lift up again.

barrel arbor, meshes successively with the teeth *1*, *2*, *3*, and with the last turn comes to rest on the full and raised part *4*.

The purpose of the part *S-H-R*, is to stop the movement of the alarm promptly and with precision. When the alarm starts to sound, the end *R* of the part *S-H-R* is on the highest part of the stopwork *4*, its other end *S*, which surrounds the pin *f*, does not obstruct the movement of the pallet. But when the spring has completed its 5 turns and pallet *n* is ready to rest on the uncut part of *m*, the part *R* falls into the notch *4-3*, and the other end *S* which has a small half-circular opening to embrace the pin *f*, will stop the hammer suddenly by locking the pallet *E*.

Tables of terminology

Part	Figures	Symbol
All-or-nothing piece locking-detent	1, 2, 5, 14	K
All-or-nothing piece pivot-point	1, 2, 5, 7	I
All-or-nothing piece return-spring	1, 2, 7	J
All-or-nothing piece spring-post hole	1, 2, 5, 7	w
All-or-nothing piece star-wheel pivot	1, 2, 5, 7	j
Chain	1, 2, 7	e
Chain pulley	1, 2, 5, 7	z
Canon pinion	7	10
Dial spring	7	15
Fixed pulley	1, 2, 7	E
Going-train contrate wheel pivot	3	V
Going-train counter-potence	3	x
Going-train escape wheel	3	W
Going-train potence	3, 5	X
Going-train third wheel pivot	3	T
Hour-pallet	3, 5, 6, 6a 7	4
Hour-pallet lifting-pin	1, 2, 3, 5, 6, 7	3
Hour-pallet return arm	7	16
Hour-pallet return spring (double action)	1, 2, 6b	q
Hour-rack	3, 7	G
Hour-snail	1, 2, 5, 7	F
Large-hammer	3, 5, 7	R
Large-hammer arbor	3, 5, 7	6
Large-hammer counter-spring	1, 2	o
Large-hammer quarter-pallet lifting-pin	3, 5, 7	2
Large-hammer quarter-pallet	1, 2, 5, 7	Q
Large-hammer quarter-pallet lifting-arm	5	5
Large-hammer quarter-pallet return spring	7	9
Large-hammer quarter-pallet return spring (double action)	1, 2	q
Large-hammer strike-pin	2, 3, 5, 6, 7	1
Large-hammer strike-spring	1, 2, 7	p
Push-piece	1, 2, 7	A
Push-piece socket	1, 2, 7	U
Quarter-rack driving-pin	1, 2, 5, 7	k
Quarter-rack drop-spring	1, 2, 7	f
Quarter-rack gathering-pallet (on top of the chain pulley z)	1, 2, 5, 7	r
Quarter-rack large-hammer teeth	1, 2, 5, 7	L
Quarter-rack locking-face for all-or-nothing piece	5	n
Quarter-rack locking-face for hour-pallet large-hammer lifting pin	1, 2, 5, 7	m
Quarter-rack pivot-point	1, 2, 5, 7	M
Quarter-rack quarter-snail arm	1, 2, 5, 7	c
Quarter-rack small-hammer teeth	1, 2, 5, 7	N
Quarter-snail	1, 2, 5, 7, 9, 10	S
Repeater-train (petit rouage)	3	s
Repeater-train delay-pinion (fly)	3, 8	t
Repeater-train first wheel	3, 5	Z
Repeater-train ratchet	4	v
Repeater-train ratchet-click	4	u
Small-hammer	3	P
Small-hammer counter-spring	1, 2	i
Small-hammer quarter-pallet lifting-pin	1, 2, 7	y
Small-hammer quarter-pallet	1, 2, 5, 7	O
Small-hammer quarter-pallet return spring	1, 2, 7	g
Small-hammer strike-spring	1, 2, 7	h
Star-wheel	1, 2, 5, 7, 10	H
Star-wheel jumper	1, 2, 5, 7	b
Star-wheel jumper-spring	1, 2, 7	d
Surprise-piece (Quarter-snail freedom piece)	5, 7, 9, 10	7
Surprise-piece button (Quarter-snail freedom piece button)	5, 7, 9, 10	8
Surprise piece collet (Quarter-snail freedom piece collet)	9	12
Surprise-piece pin (Quarter-snail freedom piece pin)	7, 9, 10	11
Winding-rack chain attachment	1, 2, 5, 7	D
Winding-rack hour-snail arm	1, 2, 5, 7	a
Winding-rack hour-snail arm steady cock	1, 2, 7	Y
Winding-rack pivot-point	1, 2, 5, 7	B
Winding-rack push-piece attachment	1, 2, 5, 7	C

Essay on Repeater Watches

Part	Figures	Symbol
Large-hammer strike-pin	2, 3, 5, 6, 7	1
Large-hammer quarter-pallet lifting-pin	3, 5, 7	2
Hour-pallet lifting-pin	1, 2, 3, 5, 6, 7	3
Hour-pallet	3, 5, 7	4
Large-hammer quarter-pallet lifting-arm	5	5
Large-hammer arbor	3, 5, 7	6
Surprise-piece (Quarter-snail freedom piece)	5, 7, 9, 10	7
Surprise-piece button (Quarter-snail freedom piece button)	5, 7, 9, 10	8
Large-hammer quarter-pallet return spring	7	9
Canon pinion	7, 9	10
Surprise piece pin	7, 9, 10	11
Surprise piece collet	9	12
Dial spring	7	15
Hour-pallet return arm	7	16
Push-piece	1, 2, 7	A
Winding-rack hour-snail arm	1, 2, 5, 7	a
Winding-rack pivot-point	1, 2, 5, 7	B
Star-wheel jumper	1, 2, 5, 7	b
Winding-rack push-piece attachment	1, 2, 5, 7	C
Quarter-rack quarter-snail arm	1, 2, 5, 7	c
Winding-rack chain attachment	1, 2, 5, 7	D
Star-wheel jumper-spring	1, 2, 7	d
Fixed pulley	1, 2, 7	E
Chain	1, 2, 7	e
Hour-snail	1, 2, 5, 7	F
Quarter-rack drop-spring	1, 2, 7	f
Hour-rack	3, 7	G
Small-hammer quarter-pallet return spring	1, 2, 7	g
Star-wheel	1, 2, 5, 7, 10	H
Small-hammer strike-spring	1, 2, 7	h
All-or-nothing piece pivot-point	1, 2, 5, 7	I
Small-hammer counter-spring	1, 2	i
All-or-nothing piece return-spring	1, 2, 7	J
All-or-nothing piece star-wheel pivot	1, 2, 5, 7	j
All-or-nothing piece locking-detent	1, 2, 5, 7	K
Quarter-rack driving-pin	1, 2, 5, 7	k
Quarter-rack large-hammer teeth	1, 2, 5, 7	L
Quarter-rack pivot-point	1, 2, 5, 7	M
Quarter-rack locking-face for hour-pallet large-hammer lifting pin	1, 2, 5, 7	m
Quarter-rack small-hammer teeth	1, 2, 5, 7	N
Quarter-rack locking-face for all-or-nothing piece	5	n
Small-hammer quarter-pallet	1, 2, 5, 7	O
Large-hammer counter-spring	1, 2	o
Small-hammer	3	P
Large-hammer strike-spring	1, 2, 7	p
Large-hammer quarter-pallet	1, 2, 5, 7	Q
Hour-pallet return spring (double action)	1, 2	q
Large-hammer quarter-pallet return spring (double action)	1, 2	q
Large-hammer	3, 5, 7	R
Quarter-rack gathering-pallet (on top of the chain pulley z)	1, 2, 5, 7	r
Quarter-snail	1, 2, 5, 7, 9, 10	S
Repeater-train (petit rouage)	3	s
Going-train third wheel pivot	3	T
Repeater-train delay-pinion (fly)	3, 8	t
Push-piece socket	1, 2, 7	U
Repeater-train ratchet-click	4	u
Going-train contrate wheel pivot	3	V
Repeater-train ratchet	4	v
Going-train escape wheel	3	W
All-or-nothing piece spring-post hole	1, 2, 5, 7	w
Going-train potence	3, 5	X
Going-train counter-potence	3	x
Winding-rack hour-snail arm steady cock	1, 2, 7	Y
Small-hammer quarter-pallet lifting-pin	1, 2, 7	y
Repeater-train first wheel	3, 5	Z
Chain pulley	1, 2, 5, 7	z

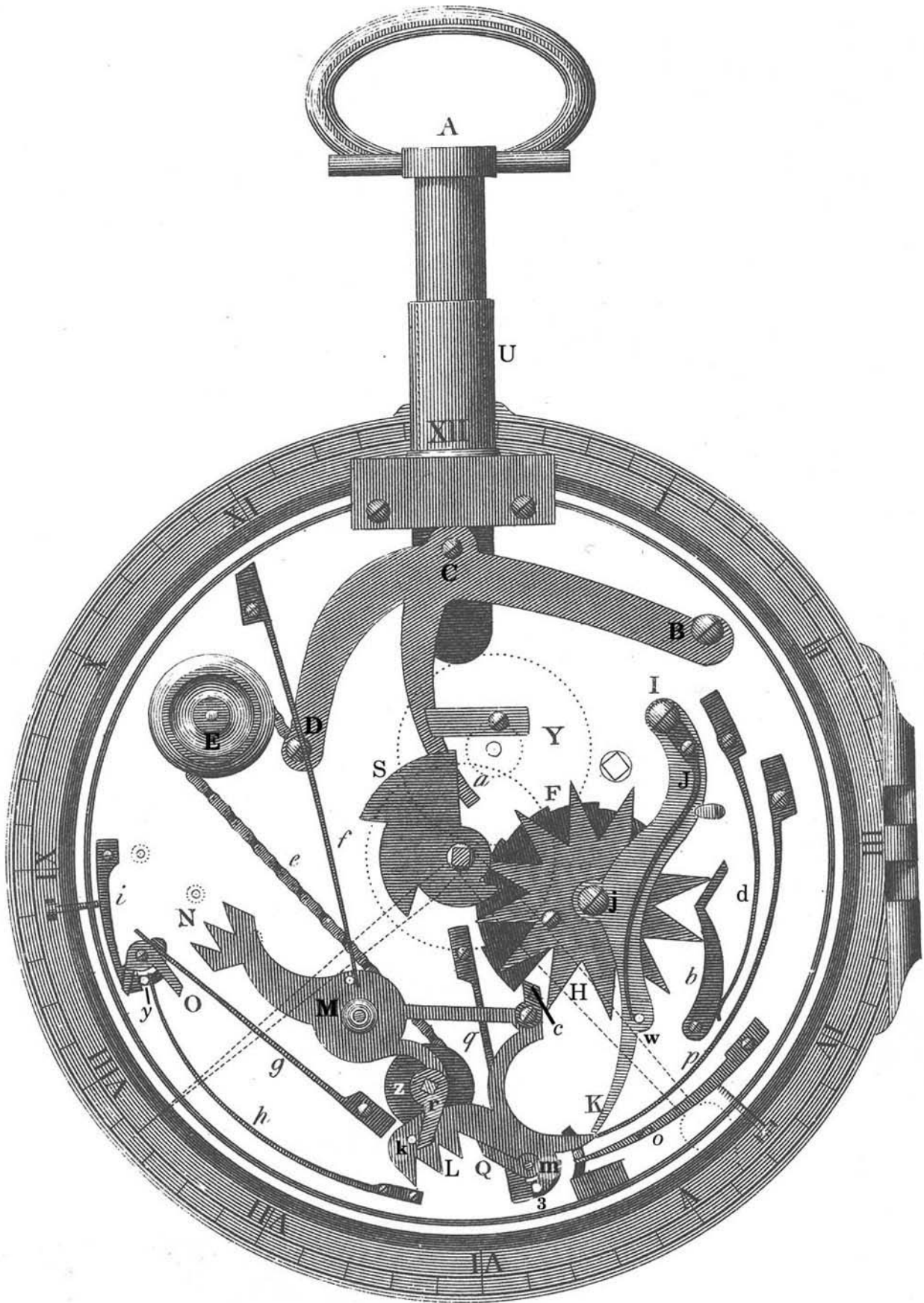

Figure 1 Repeater work at rest (From Rees, *The cyclopaedia or universal dictionary of arts, sciences, and literature*)

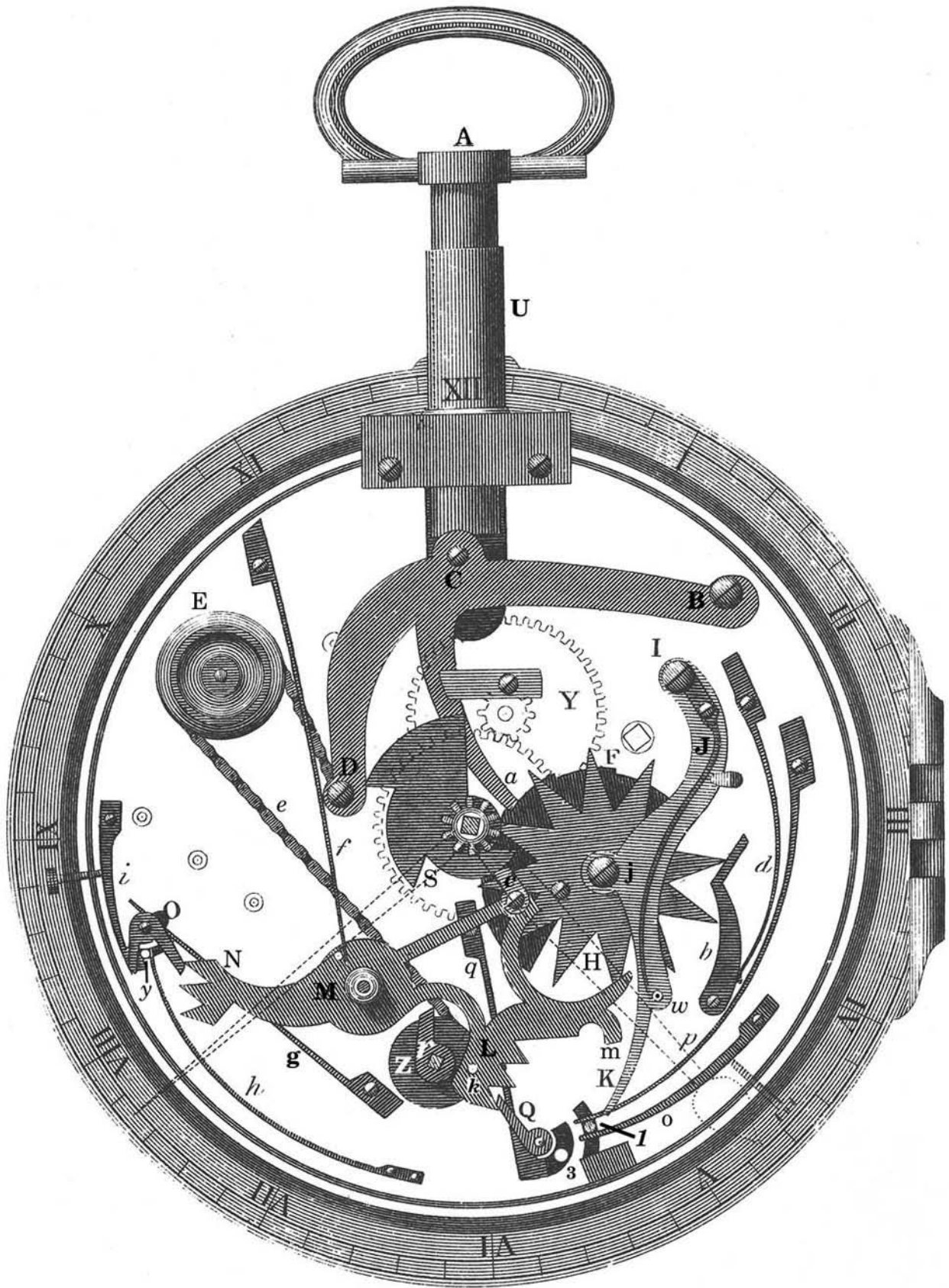

Figure 2 Repeater work ready to strike (From Rees, *The cyclopaedia or universal dictionary of arts, sciences, and literature*)

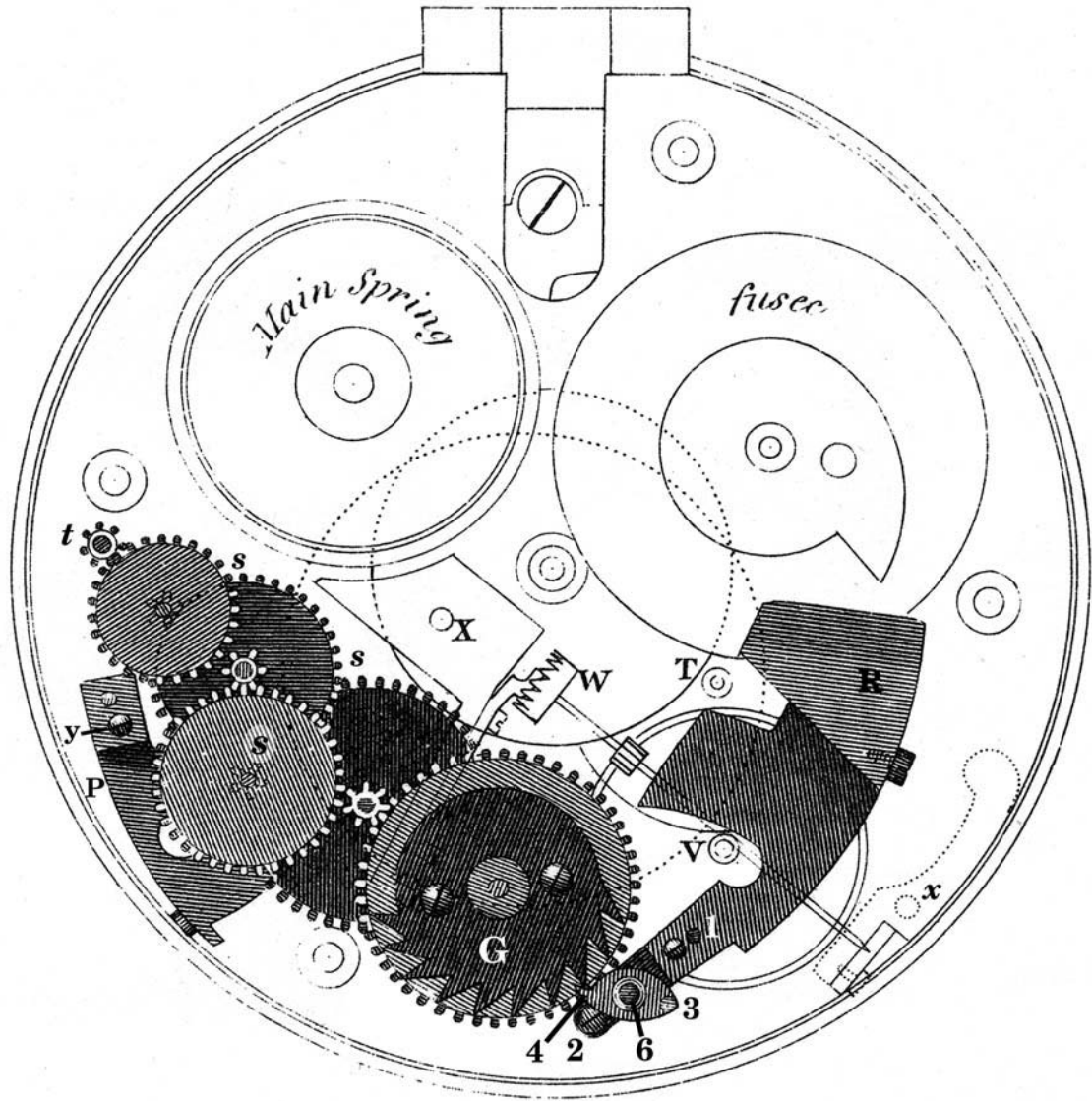

Figure 3 Repeater train and hammers ready to strike (From Rees, *The cyclopaedia or universal dictionary of arts, sciences, and literature*)

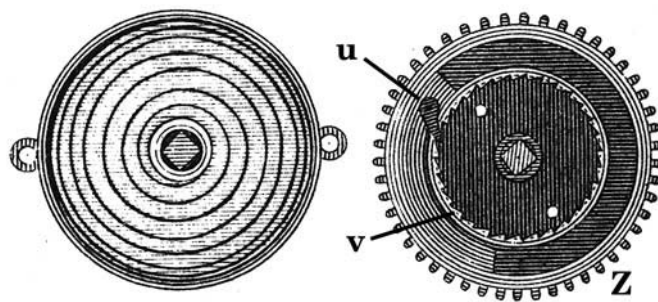

Figure 4 Repeater barrel, first wheel and click work (From Rees, *The cyclopaedia or universal dictionary of arts, sciences, and literature*)

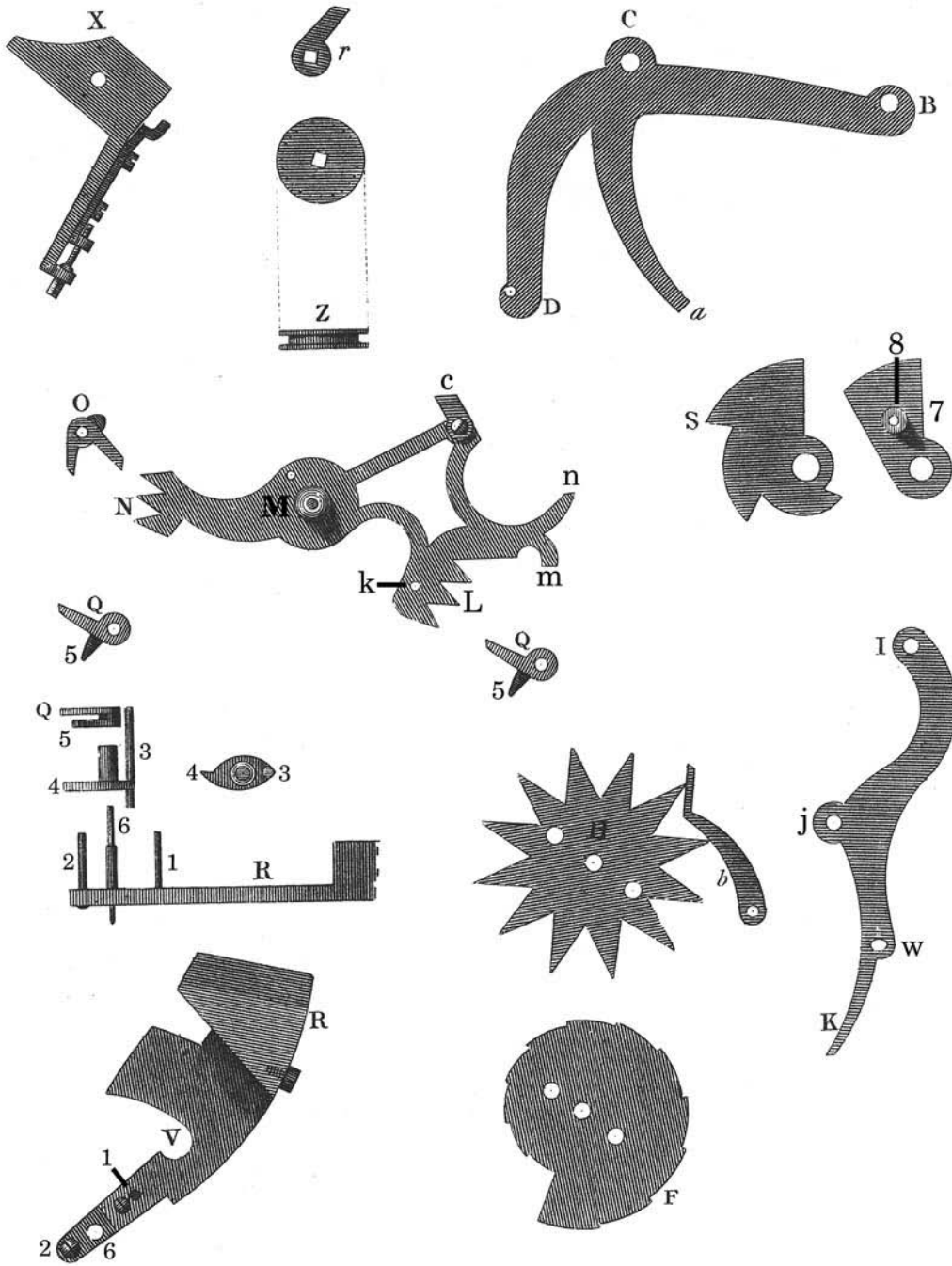

Figure 5 Repeater-work components (From Rees, *The cyclopaedia or universal dictionary of arts, sciences, and literature*)

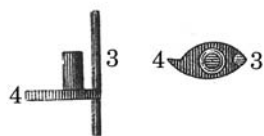

Figure 6a Modified hour-pallet

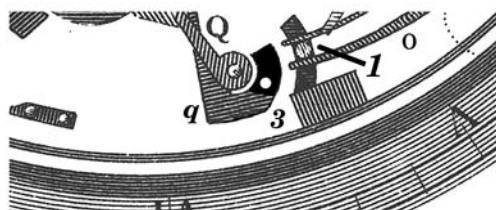

Figure 6b Modified detail from Figure 2

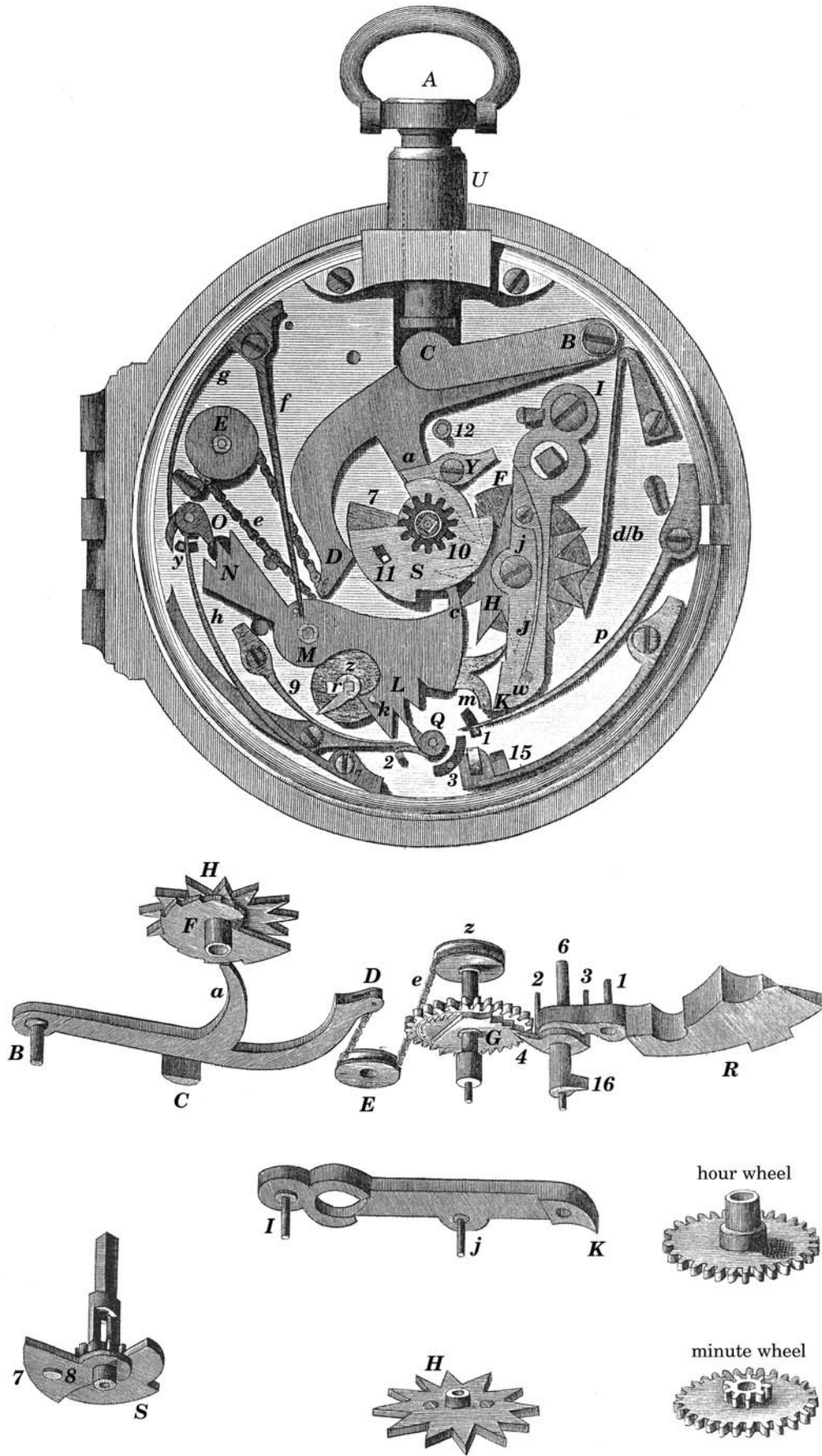

Figure 7 Repeater work ready to strike (From Berthoud, *Essai sur l'Horlogerie*)

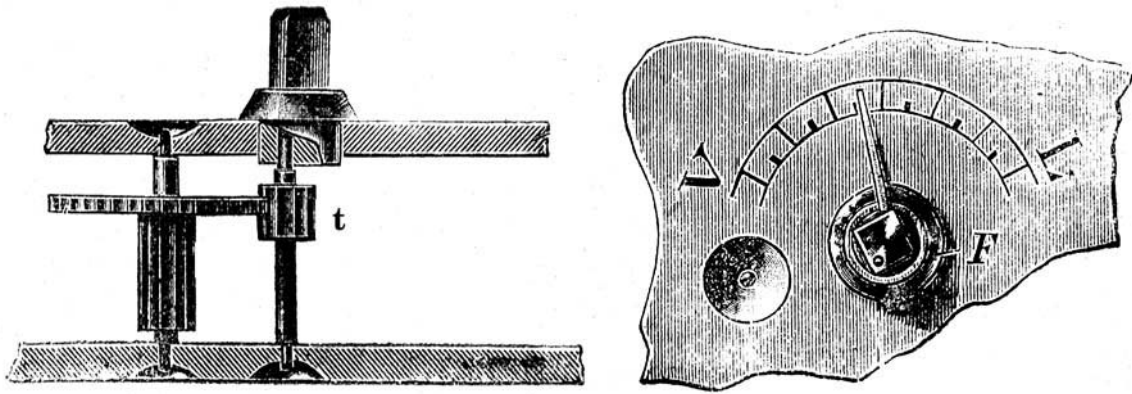

Figure 8 Repeater train delay (From Hillmann, *La réparation des montres complique*)

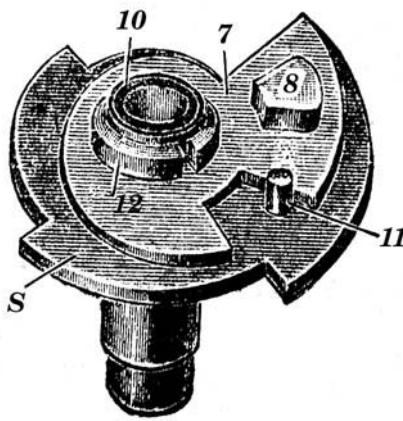

Figure 9 Surprise piece (From Hillmann, *La réparation des montres complique*)

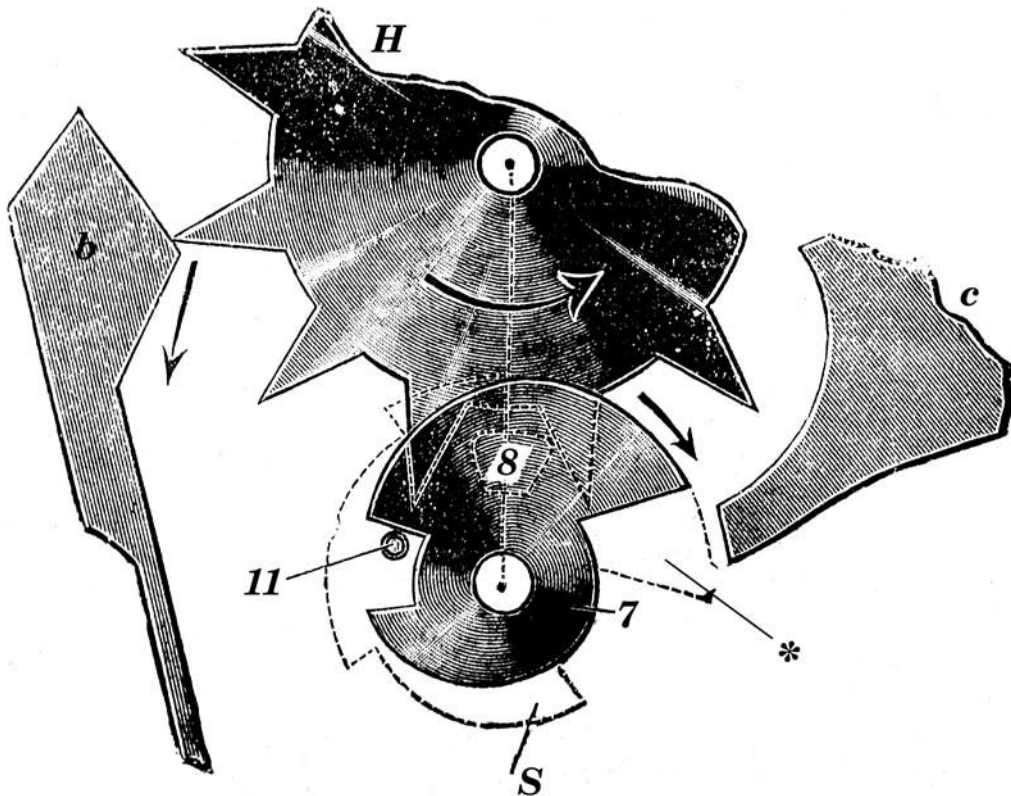

Figure 10 Surprise piece action (From Hillmann, *La réparation des montres complique*)

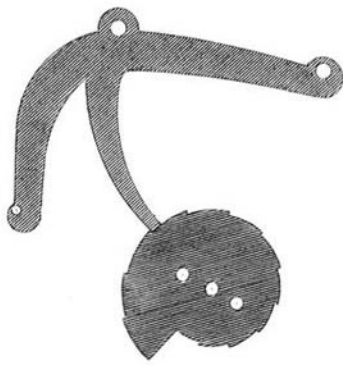

Figure 11a Normal position for hour IV

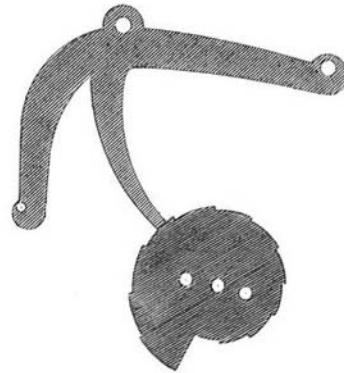

Figure 11b Position for hour IV when jumper is at point of ray

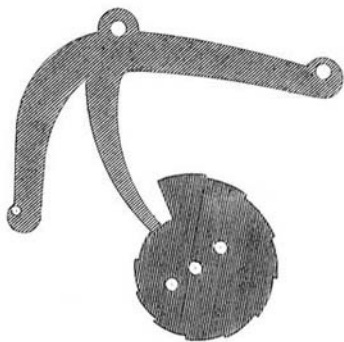

Figure 11c Normal position for hour XII

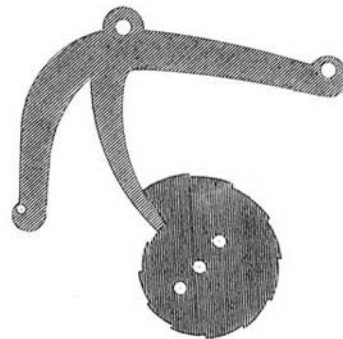

Figure 11d Position for hour XII when jumper is at point of ray

Figure 11 Winding-rack and hour-snail interaction

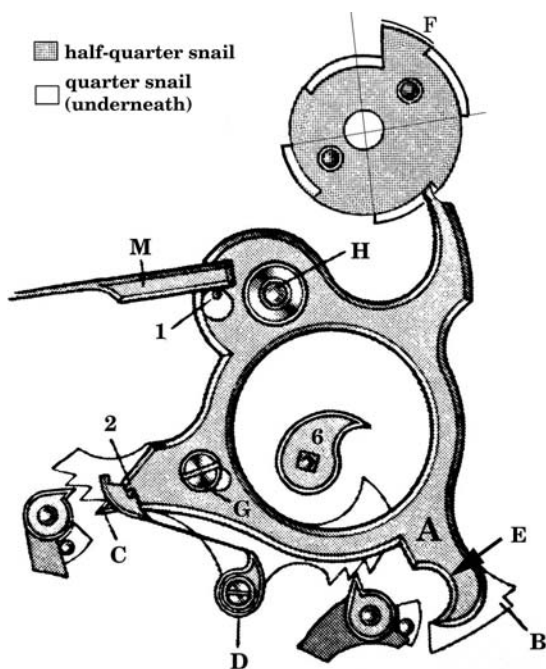

Figure 12a Half quarter position

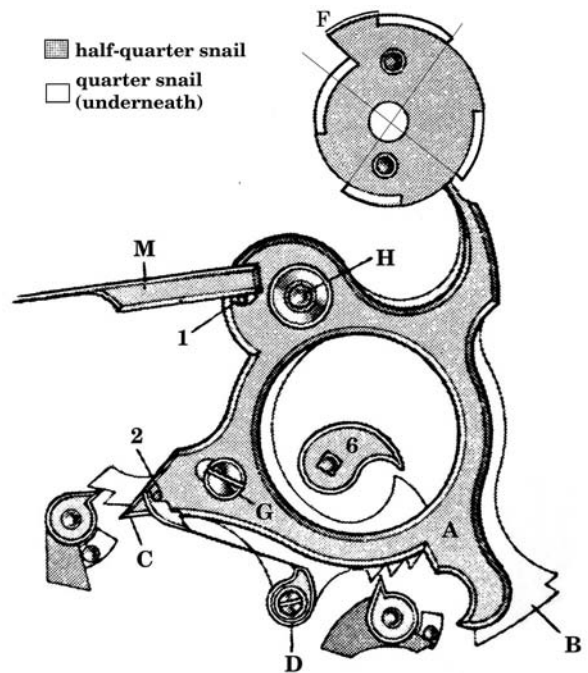

Figure 12b Full quarter position

Figure 12 Half-quarter rack (From Lecoultrre: *A guide to complicated watches*)

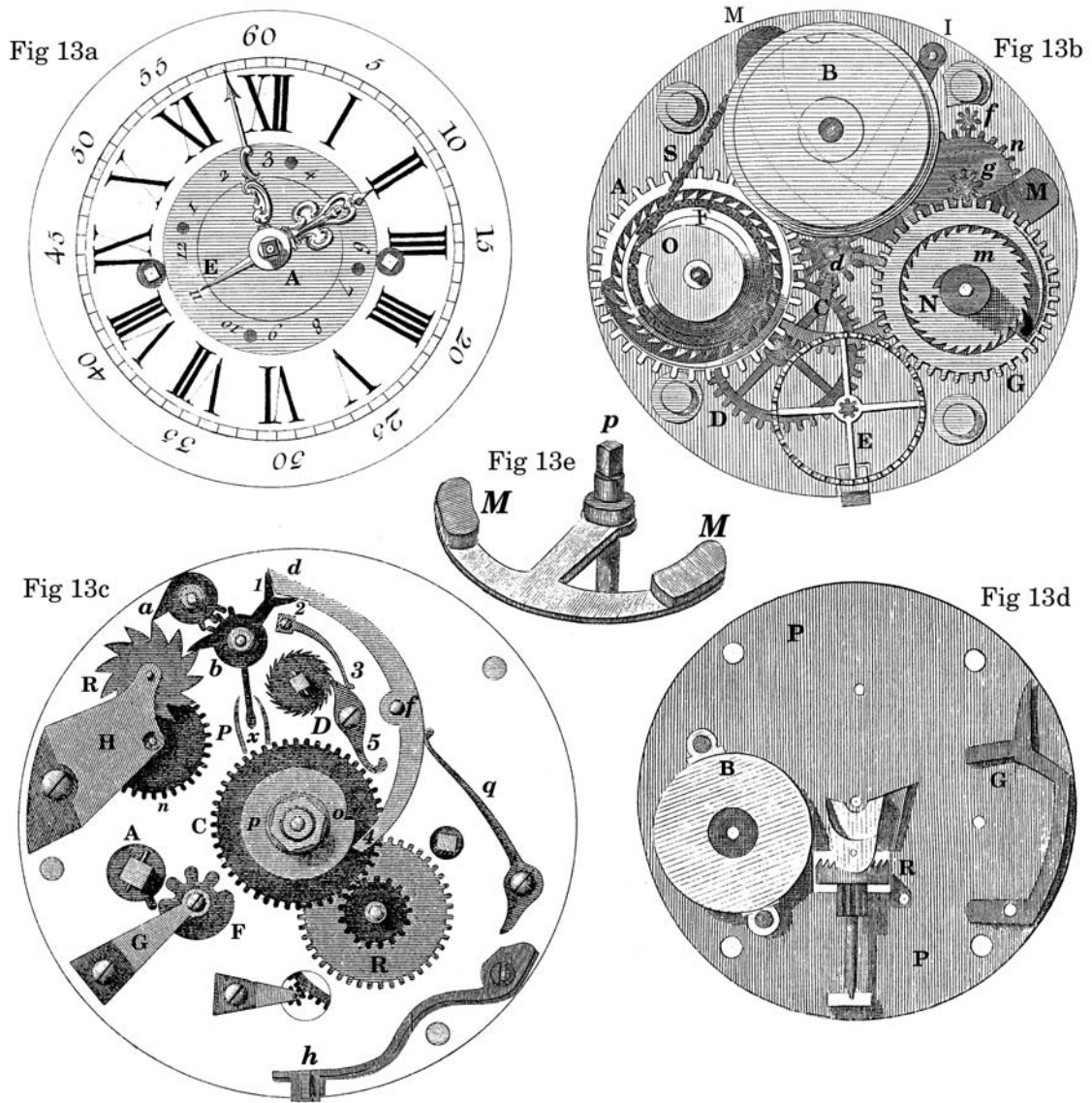

Figure 13 Moving dial alarm mechanism (From Ferdinand Berthoud *Essai sur l'Horlogerie*)

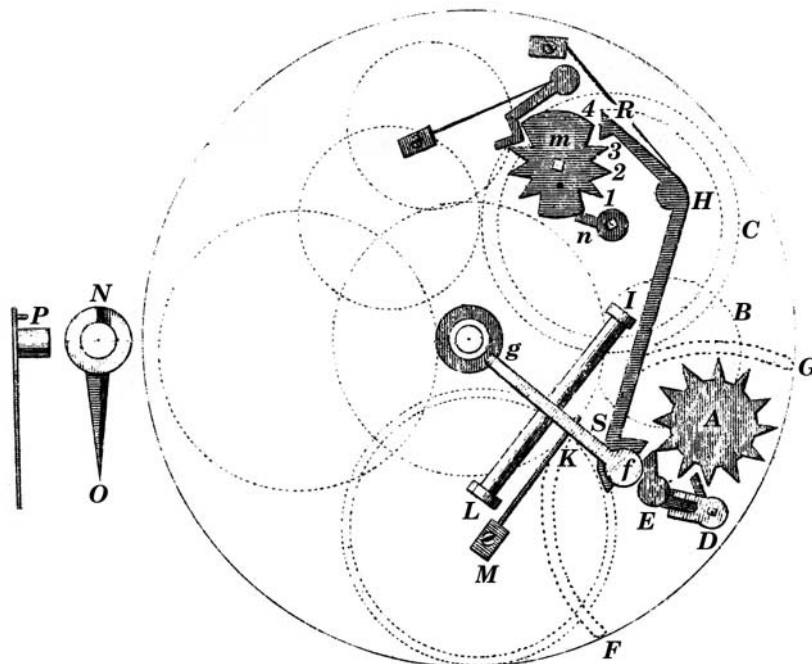

Figure 14 Fixed dial alarm mechanism (From Jean Andre Lepaute: *Traite d'horlogerie*)

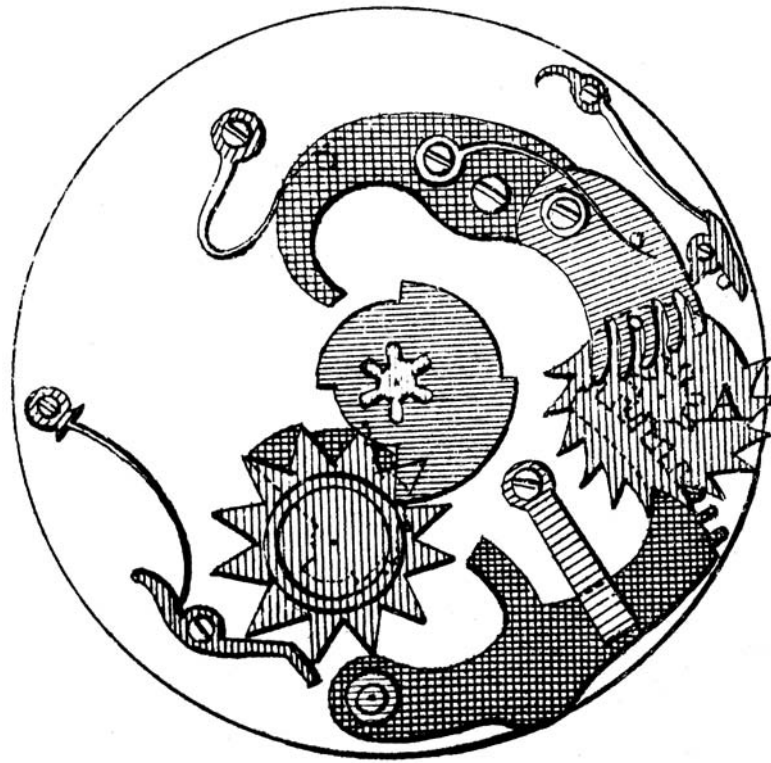

Figure 15 Early repeater mechanism using a “hand” (From Thiout *Traite de l’horlogerie mecanique et pratique*)

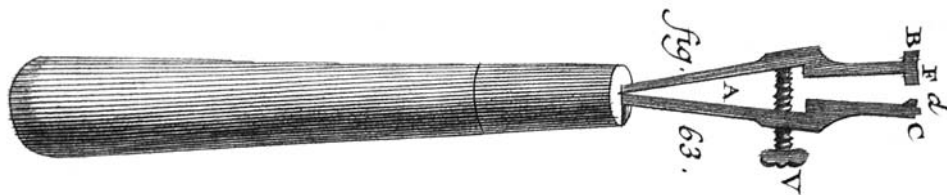

Figure 16 Equalising tool, echantillon (From Diderot and d’Alambert: *Encyclopedie ou dictionnaire raisonne des sciences, des arts et des metiers*)

Essay on Repeater Watches

Essay
On Watches
With
Repetition,

In which is treated all the parts which have to do with
this art, in the form of dialogue, for the use of watch
makers;

By François CRESPE, of Geneva.

Approved by the Society for the advancement of the arts
of Geneva.

In Geneva,
At J J Paschoud, Bookseller.
Year XII - 1804

François Crespe

EXTRACT

Of the Registers of the Society established in Geneva for the advancement of the Arts, the 11 Fructidor Year XI²⁰.

The Commissioners named by the Committee of Mechanics of the Society of the Arts, to examine a manuscript by Mr Crespe, watch maker, entitled: **Essay on watches with repetition**; found that this work is a complete exposition of the principles of the construction of watches with repetition, and that put in the hands of workmen it will contribute to shortening of and ensuring their training; all the terms of the art, such as they are known in the Factory of Geneva are employed there, and its descriptions are as clear as they can be.

The commission believes that the publication of this book, from the presses of Geneva, will contribute to strengthen the credit and reputation of the Factory of Geneva, a circumstance more essential currently than it ever was.

17 Messidor, Year XI²¹.

Signed, Mr. A. Pictet.

For the Commission.

Maurice, Secretary.

20 August 28, 1803.

21 July 5, 1803.

Preface

Horology, treated with all the insight necessary for its perfection, or even as it exists today in the hands of our more skilful artists, undoubtedly goes hand in hand with the most useful and most distinguished arts.

Moreover, all the theory and reasoning that has been developed, and the execution and practice of fine and delicate work, is joined together in horology. It is horology which presents to us masterpieces of the astonishing skill of man. It is by clocks and watches that the most significant actions of life are regulated. Finally, we can say that the order and the multiplicity of our businesses, our duties, our recreations, our exactitude with some and inconstancy in others, in fact our customs, render horology essential to us and put it at the forefront of the real needs of life.

Everyone will agree that we are indebted to our contemporaries for their application to mechanics, and the trouble they took to make new discoveries in the arts and sciences of which their predecessors had been unaware; especially in horology which improves daily to the advantage of the public, who receives a thousand conveniences from these discoveries. But among all the improvements that have been made, there is none more clever or more useful than that of repetition by work under the dial, by means of which we can know, at every moment of the day and night, the hours, the quarters and the half-quarters. Even people deprived of sight and hearing can compensate for it by a simple touch.

Thus nothing appears more significant than to seek the means, not only to preserve this art but to carry it to its perfection. The designs and experiments which remain to be made in this vast area are of sufficiently great importance to encourage the most skilful artists to contribute to it by new work.

Several learned treatises have been written on horology and, although we owe much to the scholarly authors of these beautiful works, it should be noted that they wrote only for those who were already sufficiently informed to understand them. Most of the workmen who require instruction cannot make any use of such books and there is hardly one in a hundred for whom they are of value.

Besides, they wrote about repeater-work only in an historical way, which is not very useful for workers. The scientific part of horology, which defines horological facts and without which we cannot arrive at perfection, is neglected too much; and even in the factories, which are in the hands of a great number of workmen without principles, it is ignored. Consequently, those who make repeaters do not have the means to be instructed and they are obliged to make great sacrifices, or to employ destructive expediences, to compensate for their ignorance.

For a long time the need was felt for reasoned principles for repeater-work, to reduce the difficulties that a great number of workmen fear meeting when making it. It is what decided me to yield to the requests of our more erudite artists and publish a book in the form of methodical lessons suitable for workmen, at a moderate price, and which can be used for instruction in all workshops. This book was originally written only for my own workmen, because I started the project to make them understand the need to work by principles. But other workmen, finishing or assembling repeaters, asked me to communicate it to them. I made copies and I had the satisfaction of seeing these workers undertaking, with only this help, things which they dared not make before.

We cannot doubt that it is the fear of meeting too many difficulties which prevents the majority of workmen from understanding repeater-work. Indeed, we must be surprised by the aspect which it presents. A great number of parts act one upon the other under the force of a weak motor already used to drive a train. It is only by the harmony of all these parts that we can secure their correct action.

This book serves to overcome these difficulties. It will help those who want to dedicate themselves to this branch of horology so much so that any intelligent workman will be able, without any other help, to finish, assemble and repair repeater-work.

Lastly, all those who are called to this ingenious work, in some way or other, will find new and invaluable methods.

Do not expect to find here a regular and methodical plan, but rather a want of care, repetitions and a common and uneven style. These could not be avoided in writing which was continuously interrupted by my work, which needs required that I devote all my time. However, if it has some merit, I hope that these defects will be excused, and my good intentions will be known. I request the reader studies it before judging it.

Plan of the book

However, to put order in this work I divided it into three parts. The first contains a reasoned description of repeater-work, in the form of lessons by questions and answers. I go into all the details of hand work, to make its execution easy for all intelligent workmen. This first part is preceded by definitions of the principal terms of the art of horology as an aid to understanding this book, and a short essay on the origin and progress of horology.

The second part deals at length with casing, because the finishing of repeater-work is united with this part. With it there is a necessary recapitulation to make clear how very important it is to thoroughly

understand repeater-work in order to transmit the motive power in a uniform way through the mechanism; the action of levers upon each other, the force distributed by each of the springs, their elasticity and their proportions, the sum of frictions reduced to the least possible quantity at the point of support, the easy and energetic action of the hammers acquired by their accelerated descent, the point of contact and impact on the bell, the position of the bell and its vibrations, and the definition of sound bodies. You will find here the necessary directions for laying out the parts and making cases which produce harmonious sounds. I have added instructions for the use of people who are required to examine and buy repeater-works, so that they can judge their qualities and know their construction; a study which is likely to be useful.

The third part is devoted to case finishers, movement finishers and assemblers, on whom the fate of the repeater entirely depends; because well made repeater-work will always fail in operation if those who complete it do not have sufficient knowledge to prevent all the changes which gilding can cause. This is why they will find in this part the manner of finishing, examining its action when disassembling and how to assemble it after gilding.

The book finishes with a collection, as curious as interesting and new, of all the known causes which stop the action of repeaters, with methods of detecting and repairing them. This collection is not only useful to all workmen in factories who make repeaters, but even more so to those who are remote and who, not having the knowledge to repair them, are forced to use methods which tend to damage rather than fix them.

Here is the goal that I proposed for this book. The plan that I tried to fulfil is founded entirely on valid methods, and undoubtedly deserves a pen more skilful than mine. But the importance of the subject will compensate for any weakness of my talents. At least I hope that, after censuring the faults, you will be grateful for my endeavour and will render justice to me. I will be happy if, by contributing to help those people whose talents in horology can (in the future) make it flower more and more in the Republic, to her honour and ornament, and so merit the glorious title of citizen and true patriot.²²

22 At the time that Crespe wrote, Geneva had been annexed to the French Republic.

Definitions

Principal terms of the art of horology, to be used for the understanding of this book²³.

A.

Acheveur, remonteur. *Berner's "Dictionnaire professionnel illustre de horlogerie" defines these as a fitter (or finisher) and an assembler respectively. Crespe uses the words in the sense of examination and final assembly; for example, the acheveur or remonteur of gilded movements.*

Acier, steel. A quality of iron refined by nature or art, so that it is the hardest of all metals.

Acier tiré, drawn steel, pinion wire. A steel rod drawn through a grooved die which shapes it to make pinions of various numbers, according to the die through which it passed.

Aiguille de montre, watch hand. The part which marks the hours and the minutes.

Ailes, leaves. The teeth of a pinion.

Angle. The space between two lines which join at a point. Angles are characterised by degrees, according to the more or less large opening which they have.

Angulaire, angular. The term for parts which have the form of an angle.

Anneau, ring, collet. Ring which is driven around an axis; a link of the chain which is driven by the winding-rack or *crémaillère*.

Arbre, Axe, Tige et Verge, arbor, staff, stem and verge. These are synonymous terms; the axis of the first wheel is called the barrel arbor, of the contrate wheel the arbor, etc. An axis which needs strength to support a large weight is called an axle.

Arc. Part of the circumference of a circle, less than half.

Assiette, seat. That which supports something; the seat of a wheel is the part on which it is riveted.

Atmosphère. It is the air which surrounds the Earth and which has an equivalent weight of approximately twenty-eight inches of mercury. Its changes contribute to rendering the vibrations of a balance irregular.

Atomes, atoms, dust. These are small particles which fill the air and which contribute to making clocks and watches dirty, mainly those which are not well sealed.

Axiomes, axiom. An unquestionable fact, an undeniable truth.

B.

Balancier, balance. A ring of steel or brass²⁴ which is driven by the escapement; it is that which makes the vibrations in a watch.

Barette. A small, thin plate or bridge attached to plates for recessing (sinking) wheels.²⁵

Barillet, barrel. Part in the shape of a drum which contains the motive spring of the watch or the repeater-work.

Barillet tournant, revolving barrel. A barrel which carries a wheel.

Barillet double, double barrel. A barrel which has a wheel at each end.

Barillet fixe, fixed barrel. A barrel which has a mobile wheel in its center.

Base. Generally the lower section of a part, whatever it is, such as a cone or a cylinder. The ratchet of a fusee is fixed to the base of the fusee.

Bate, *collar, false-plate, dial-work frame. The plate with its collar which is between the dial and the pillar plate of the movement, hiding the repeater-work.*²⁶

Bate, flange, movement seat. It is the circle of a watch case which has a groove to hold the false plate (dial-work frame) of a movement, to which is attached the small hinge.

Borax. Mineral juice which is found in mines and which solidifies. The best for soldering is the yellow, called *chrisocolle*. There is also borax which is made artificially, from saltpetre, etc. Calcined borax is made so that it does not dislodge the solder when it is dried off too quickly.

Brunir, burnish. To give a polish to metals; it is done with a tempered and well polished steel tool called a burnisher.

C.

Cadran, dial. The part of the watch on which the hours are marked.

23 I have added a few definitions and comments to those provided by Crespe, with my additions given in italics. I have retained the order and the French key-words. Crespe was clearly a practical man and not comfortable with abstract terms (see, for example, his definition of a cone). I have not corrected his definitions when I believe the meanings of words are obvious.

24 Like other writers (such as Berthoud) *cuiivre* is used for brass; *cuiivre* is copper and *cuiivre jaune*, yellow copper, is brass.

25 There is no satisfactory English equivalent.

26 Crespe writes about *la bate ou cercle* (the collar or circle) when he is discussing what I translate as the *repeater-work frame*.

Note that Crespe sometimes uses geometrical terms for physical objects; here *circle* means a thick disk.

- Cadran universel**, universal dial. A dial that shows the hour at the principal places on the Earth.
- Cadrature**, repeater-work, dial-work. *Crespe uses the spelling quadrature (the use of qu in place of c was common). Cadrature consists of the parts placed under the dial to control additional mechanisms. I use the term repeater-work except in a few places where Crespe is talking more generally; then I use dial-work or retain the French cadrature.*
- Cage**, frame. The two plates with their pillars that hold all the wheels, springs, chains etc.
- Calibre**. The plan or design of the parts which make a watch.
- Calotte**, dome. The part of the case which contains the movement of a watch, to exclude dust.
- Canon**. As it indicates, it is hollow internally.
- Centre**. It is properly the point in a circle which is equally distant from all points of the circumference.
- Centre de mouvement**, center of motion, pivot-point. The point around which a circular motion is done.²⁷
- Chaîne**, chain. That which is used for the fusee and is made of small oval links. The tool to make them cuts and punches each link with one blow of a hammer.
- Champ**, contrate. Wheels whose teeth are parallel to their arbors are called contrate wheels; that of the escapement, which has the same form, is called the crown wheel (*roue de rencontre*)²⁸.
- Chaussés**, canon pinion. The canon on which the hand is placed.²⁹
- Charnière**, hinge. The part attached to the pillar plate (or the repeater-work frame in repeaters) and the case by which one can open or close a watch movement.
- Chute**, drop. Term which is used to explain the action of gearing: drop is synonymous with shock.
- Circle**. *See bate.*
- Cylindre**, cylinder. A round body of equal size.
- Clef**, key-screw. A screw with a hook which locks the repeater-work frame to the pillar plate, or locks other parts.³⁰
- Cliquet**, click or pawl. The part which retains the ratchet and the spring tightened in a barrel.
- Coq**, cock. A support and cover for the balance.
- Coqueret**. The part attached to the cock which carries the pivot of the balance.
- Contre-potence**, counter-potence. The part which, with the potence, is used to carry the escape wheel.
- Cône**, cone. Shape like a pyramid, a fusee. A cylinder larger at one end than the other has a conical form.
- Convexité**, convexity. It is the roundness and the height of, for example, a watch glass; and concavity is the inside.³¹ A watch glass does not have enough concavity when it touches the minute hand. The word can apply to all parts of this form.
- Coulisse**, slide. The half-circle under which moves the rack which guides the balance spring.³²
- Crémaillère**, winding-rack. The part of the repeater-work on which the push-piece acts and which drives the chain.³³
- Crochet**, hook, *beak*. A steel plate on the fusee, in the shape of hook, which is used to stop winding. There are several types in watches.
- Croisées**, crosses, spokes. The spokes which maintain the center of a wheel.

D.

- Délai**, delay. The last pinion of a striking train which is thus named because it is used to slow down the speed of the striking.
- Dents**, teeth. This means various things. The same part in a pinion is called a leaf.
- Détente**, detent. There are several kinds of them. Their use is to release striking.
- Dial-work**. *See Cadrature.*
- Dial-work frame**. *See Bate.*
- Doigts**, finger. Part which returns the quarter-rack, the quarter-rack gathering-pallet.
- Dos-d'âne**, donkey-backed. A body having two surfaces tilted towards each other and which form an angle.

27 Crespe often uses *centre* in the context of the *center of a piece*, such as a lever, where he means its point of movement. I have used the term *pivot-point*.

28 As *crown wheel* is ambiguous, I use *escape wheel* throughout.

29 English does not distinguish between the canon and its pinion.

30 I use the term *key-screw* rather than the more familiar *dog-screw*.

31 See the definition of *height*.

32 The rack carries the regulator pins.

33 It is also called the repeater-rack. It isn't really a rack, having no teeth, and the term *crémaillère* is often used in English texts. I use *winding-rack* as it is more descriptive of the part. In some repeaters the *crémaillère* is a rack with teeth. In these watches there is no chain and the *crémaillère* gears into a wheel on the repeater barrel.

Dragéoir, groove, snap. A groove or snap which holds, for example, the glass of a watch, the cover of barrel etc.

E.

Échappement, escapement. The part which escapes by the impulse from a wheel, like the pallets of a balance verge, etc.

Ecrouir, hammer harden. To forge brass to make it hard and stiff, because hammering tightens its pores.

Efflanquer, to thin. We say “thin a pinion” to say to *vider*, to cut away the inner angle to obtain a sharp corner.³⁴

Egaler, equalise. To equalise a pinion or a wheel is to make all the teeth the same.

Elastique, elastic. Quality or virtue of a body which makes it springy, such as tempered steel.

Embichetage. The term which is used for determining the size of the top plate of a watch so that it does not touch the case when the movement is opened or closed.

Encliquetage, click-work. The term used when we speak of a ratchet, click and its spring together.

Engrener, engage. It is the effect of a wheel tooth which enters the leaf of a pinion.

Equation. The difference between true time and mean time, or the apparent variation of the sun compared to the equal hours of the watch.

Equilibre, equilibrium. A weight which is equal to another.

Etoile, star-wheel. The star-wheel of a repeater snail. It is a disk divided into twelve arms which finish in points or *rays*.

Excentrique, eccentric. A circle which has another center than that where it is contained.

F.

False plate. See Bate.

Force. Signifies power; moving force is the same thing as power. The moving force can only be increased by more speed and what is gained in time we lose in force. It is the principle of all mechanics.

Fraiser, to mill. In the terms of this art, it is to remove the small point of wheel teeth.

Frottement, friction. We cannot move even one thing without friction. All parts which are driven, and all which drive, on the principle of the lever have less friction than those which are moved by incline planes.

Fusée, fusee. The conical part on which the chain is wrapped to draw movement from the watch.

G.

Garde-chaîne, chain-guard. It is the detent of the fusee beak, to prevent the chain breaking.

Goupille, pin. A small point in form of a removable wedge (or key bolt) to hold together, for example, the frame of a watch and many other parts.

Goutte, collet. A small round plate, convex on one side, which is used to retain wheels or other parts.

Graduer, to divide. To divide into as many parts as one needs.

H.

Hauteur, height. *Most of the time Crespe uses the word hauteur in ways that are clear, but in a couple of places I found his use a little obscure. Height can be defined as the distance, measured along a straight line, between two points on an object. This is not necessarily the common use of the word because I can talk about the height between my nose and my ears. Another example is the height between your hand and your shoulder. It is variable and less than the length of your arm except when your arm is straight.*

Horizontal. It is all that sits level. The balance of a watch is horizontal when the watch lies on a table and vertical when it is hung.

I.

Jeu, shake, play. Indicating that a part has freedom.

Incliné, incline. In horology a tilted plane or slope. All kinds of parts on plates whose direction does not tend to the center of the plate.

Index. A small fixed pointer which indicates the divisions engraved on a moving circle.

Isochrone, isochronous. It means equal. The vibrations of a watch are isochronous when they are equal.

L.

Lardon, plug. The long piece which is put in the slide of the potence to carry the escape wheel.

Levée, lifting pallet, gathering-pallet. It is a small lever placed free on the arbor of a repeater hammer.

Limaçon, snail. The hour-snail is a circle turned or formed spiral and divided into twelve sections to regulate the blows of a repeater hammer. The quarter-snail is divided into four sections.

M.

³⁴ *vider*, to empty, to clear.

Machine. A machine is a compound of several parts used to increase the force or power to move or to stop a weight. To stop is to put in equilibrium, to move is to take away equilibrium.

Maillon, link. A small part, used to make watch chains, in the shape of an oval pierced with two holes.

Main, hand. A part divided into four fingers which is sometimes used in repeaters. Though its use is good, it is now only employed in certain cases.³⁵

Mécanique, mechanics. The art of designing all kinds of moving machines. We say “the mechanics of a machine” for the effect of the parts which make it up.

Marteaux, hammer. A mass of steel carried by an arbor and placed in the frame of a repeater to strike against a bell or gong.

Microscope. A type of glass which enlarges objects extraordinarily and assists the discovery of the least defects in a watch.

Mobile. Anything that has movement.

Montre, watch. A portable clock which marks the hours, minutes and seconds, strikes the hours and the quarters, repeats and awakes. The art of making watches is so sophisticated that they are constructed to produce many surprising effects.

Mouvement, movement. A physical term for the action by which a body is driven. There are four things to consider in movement; the mass of the body which is driven, the space which it traverses, the time that it takes to traverse it, and the slope up which it is driven. It also means the parts which make up the insides of a watch.

N.

Nombre, number. The quantity of teeth given to each wheel of a watch so that it makes the desired revolutions; a *rentrant* (re-entering) number is when the number of a pinion exactly divides the number of the wheel into which it gears.

O.

Oblique. A line which is not vertical and opposed to a straight line.

Oreilles d’un coq, ears of a cock. The two feet on the cock by which it is fixed to the plate with two screws.

P.

Palette d’une verge de balancier, pallets of a balance verge. They are the levers which engage the escape wheel; we say *width* of the pallets improperly for what is *length*, since they are based on the principle of the lever. Thus levers are wider than others according to their distance from the escape wheel teeth.

Perpendiculaire, perpendicular. A straight line which falls onto another line.

Pignon, pinion. A small toothed wheel placed at the center of a large wheel to multiply the turns of the later wheels; the teeth of pinions are called leaves.

Piliers, pillars. They form the frame of a watch by supporting the plates at the distance which one wants.

Pivots. The ends of arbors, stems etc. which enter holes in the plates to turn freely there.

Pivot-point. See *Centre de mouvement*.

Platine, plate. One of the plates of the frame of the watch.

Podometre ou Comptepas, pedometer or step counter. It is an instrument in the shape of watch which is used to measure the distance that one goes. It is made up of a wheel of one hundred, another of one hundred and one which gears into a pinion of six. Each step taken drives this pinion by a cord attached to the knee. It moves a type of escapement which causes a star-wheel on the pinion arbor to jump and which makes a hand to move one mark on the dial, while another wheel turns each hundred steps and the other hand marks the hundreds. This machine can be adjusted for post chaises etc.

Pont, bridge, bar, cock. A fixed part that is used to hold parts which cannot be held by the plate.

Pores, molecules. All metals and minerals are composed of small pieces which are called pores; gold has its pores closer together than steel, which makes its volume heavy.

Portée, shoulder. The seat of a pivot.

Potée, putty. Tin calcined and reduced to a very fine powder, and used to give the final polish to steel.³⁶

Potence. Type of cock which holds the verge of the balance and supports the escape wheel. The counter-potence is the part which supports the other end of the escape wheel arbor.

Poulie, pulley. Ring whose circumference is grooved to contain a chain.

Poussoir, push-piece. It is the pendant of a repeater which, by pushing it, makes the watch strike the hours and quarters.

35 The hands I have seen illustrated have five fingers; see, for example, Figure 15.

36 This is quite different from the English watchmaker’s putty which is made from bread.

Puissance, power, force. Term of mechanics; what must act to move, or to be moved.

Pulsation. A wheel which engages near the center of a pinion has less pulsation than if it acted on a pinion of a larger diameter.³⁷

Pendule, pendulum. A rod of some length which is suspended in clocks to regulate their motion.

Planer, planish. To forge a plate with small blows until it is well flattened.

Q.

Quadrature. The parts placed under the dial. *See Cadrature*.

R.

Rateau, rack. Portion of a toothed wheel which is employed in a slide to advance or retard the index.

Rayon, radius, spoke. It is a straight line drawn from the center of a circle to its circumference.³⁸

Recuire, anneal. To redden metals to soften them and make them more malleable. *See Rouge*.

Repeater-work. *See Cadrature*.

Reperts, guide marks. Marks which are made on wheel teeth and other pieces so that they can be set in their correct positions.

Répétition, repeater. A watch which repeats the hour that it indicates as many times as one wants.

Ressorts, springs. Tempered steel blades which, being elastic, are used to give movement to all sorts of parts.

River, to rivet. To drive metal back with the blows of a hammer to fix two parts together.

Rochet, ratchet. A wheel whose teeth are finished in points. It is used to make the hammers strike, and for many other purposes.

Rosette. A small, arbitrarily numbered dial which indicates the direction in which it is necessary to turn the pointer to advance or retard the going of a watch.

Rouage, train. The toothed wheels which gear into pinions and drive all that one wants to move.

Rouge, red. A piece which is hardened in cold water. It is then tempered according to the use to which it is to be put.³⁹

S.

Sautoir, jumper. A type of click which is used to hold the repeater star-wheel in position; it is also called the *valet de l'étoile*.

Seconde, second. The sixtieth part of a minute of time and of a minute of degree.

Soudure, solder. Metal made of silver and brass to join, with borax, pieces of the same metal.

Sourdine, silencer. Part of a repeater against which one puts a finger to feel the blows that it strikes. *See also Toque*.

Surprise, surprise-piece. Moving part under the quarter-snail which is used to make the hour change suddenly.

T.

Talon, heel. The part of the winding-rack on which the push-piece acts; the part of the potence which supports the balance verge is also given this name.

Tremper, harden. To give a hard quality to steel by throwing it red.

Tout-ou-rien, all-or-nothing piece. The part of repeater-work which is used to ensure striking only with the indications.

Triangle. A figure comprised of three lines and which has, consequently, three angles.

Toque, touch piece. The part attached to the case of a repeater to cut off the sound of the gongs at will.

V.

Vibrations. The arc of a circle which a moving balance describes.

Vis, screw. A cylinder fluted in a spiral which enters a nut, of which the interior is formed in the same way. The interval of the screw threads is not named. The larger the screw and smaller the steps the more its strength increases.

Vis-sans-fin, endless screw. Used to tighten the springs of a watch.⁴⁰ It is commonly employed to make wheels move slowly.

Volant, fly. A brass part placed on the arbor of the last pinion of the striking train to slow down the speed of the blows.

37 Obscure. It may be the freedom (drop) in gearing or recoil.

38 Crespe also uses this geometrical term for pieces such as the spokes of a wheel.

39 Crespe uses the words for colours by themselves to indicate heating steel to that colour.

40 The old method of setting up the mainspring in a fusee movement.

Part 1 - Repeater-work

Lesson 1 - The origin of horology

Question When was the origin of horology?

Answer The discovery of time measurement by moving wheels occurred at the end of the sixteenth century.⁴¹

Q. Until then, how did we measure time to regulate the actions of life?

A. By the daily revolutions of the sun. The Romans were the first to divide the day into twelve hours and the nights into four parts, called watches. Then sundials, clepsydras, sand glasses and so on were invented.

Q. What are clepsydras and sand glasses?

A. Clepsydras are bottles constricted in the middle and the two ends are the same size. One end is filled with water or another liquid, and it takes some time to pass the constricted neck in the middle until it fills the other end. Sand glasses are those which are filled with sand. Some are still seen in churches, in the pulpit of the preacher, to show the duration of the sermon.

Q. These instruments were prone to many problems; we could not know the hour during the night, nor when the sun was hidden by clouds. Is it known who invented the first striking clocks?

A. In 1650 Gerbert, a monk who was then Archbishop of Rheims, rendered this significant service to all monks in monasteries⁴². They were obliged to have people observe the stars during the night and to inform them of the correct time for their offices. It is at this time that we can fix the origin of horology.

Q. These clocks were quite crude and were placed in bell-towers. How then did we manage to make watches?

A. Skilful workmen made smaller clocks to place in rooms and finally the portable clocks which we call watches. It is properly with this last discovery that the art of horology begins; not being able use weights meant it was necessary to find another agent or engine, which is the coiled spring in a round box called a barrel.

Q. Which discovery was made next?

A. That of the spiral spring in 1660, by the famous mathematician Huygens, who adapted it to the balance to regulate the speed and movement of it. Huygens much improved horology.

Q. How were striking watches invented?

A. From the first use of toothed wheels, horological artists desired to invent various mechanisms; such as alarms, the days of the month, the days of the week, the years, months and phases of the moon, sunset, leap years, and so on. But among all these additions there are two which are very ingenious, still very useful and which were invented in this century.⁴³

Q. What are these additions?

A. The first is repetition, by means of which we can know the hours and the quarters at any moment of the day or night. The second is the invention of equation clocks and watches.

Q. What are equation watches and clocks?

A. To understand the merit of them you should know that after many observations astronomers discovered that the daily revolutions of the sun are not always done in same time. That is, the time between one midday and the next is not always the same, but it is longer on certain days of the year and shorter on others. However, the time measured by clocks is uniform and consequently they cannot follow the variations of the sun. So we invented a mechanism which, while the minute hand of the clock has a uniform movement, makes another hand follow the variations of the sun. Finally spheres and planispheres are admirable productions of horology.

Q. What is a sphere?

A. A sphere is a machine laid out so that it indicates and imitates, at all times, the positions of the planets in the sky, the location of the sun, the movement of the moon, the eclipses; in a word, it represents the system of the universe in the small.

Planispheres mark all these revolutions in the same plane, like a dial.

Q. Please tell me how all these are made to move?

A. By circles, driven by wheels, on which the planets are marked. They are seen through an opening made in the dial.

41 Crespe's knowledge of history is poor!

42 The Gerbert commonly mentioned in regard to horology lived around 1000 AD.

43 This comment indicates that the book was written before 1800.

Lesson 2 - Divisions of clock and watchmakers

- Q.** What are the divisions of clock and watchmakers?
- A.** There are three classes, the horologists who make bell-tower clocks, the pendulum clock makers, and the horologists in the small.
- Q.** How does one classify the workmen who manufacture watches?
- A.** Their number is very large. The main ones are the following:
- 1 Ebauche makers (makers of rough movements for simple watches);
 - 2 Repeater-train makers;
 - 3 Repeater-work makers (cadraturiers);
 - 4 Finishers of simple watches;
 - 5 Finishers of repeater-trains;
 - 6 Cylinder or other escapement makers;
 - 7 Hinge makers;
 - 8 Repeater casers or repeater-work finishers;
 - 9 Examiners of simple watches;
 - 10 Examiners of repeaters;
 - 11 The timer who fits balance springs and regulates watches;
 - 12 Spring makers;
 - 13 Chain makers;
 - 14 Balance spring makers;
 - 15 Enamellers or dial makers;
 - 16 Hand makers;
 - 17 Engravers of cocks and names;
 - 18 Engravers of the rosette;
 - 19 Gilders;
 - 20 Brass part polishers;
 - 21 Steel part polishers;
 - 22 Verge polishers;
 - 23 Wheel dividers;
 - 24 Denturiers or teeth finishers;
 - 25 Fusee and crown wheel dividers;
 - 26 Bell makers⁴⁴;
 - 27 Case assemblers;
 - 28 Case makers;
 - 29 Engravers and chasers of case ornaments.

I will not list here the workmen who make the tools and instruments used by horologists because there are too many; anyway, they are only accessories to hand work.

- Q.** Do all the kinds of work done by these people have to be included in the study of horology?
- A.** Yes, undoubtedly. The watchmaker must supervise his workmen and judge their abilities and the faults in their work.

44 *timbre*, but Crespe includes gongs as we shall see later.

Lesson 3 - The characteristics of a good watchmaker and the means of acquiring them

- Q.** What characterises a good watchmaker ?
- A.** It is a perfect knowledge of all the parts together with a high degree of accuracy in making them and a good knowledge of theory.
- Q.** What is necessary to achieve these?
- A.** It is initially necessary to choose a master who has all these qualities and who, moreover, will demonstrate them with kindness, devote himself entirely to work and make his recreation the study of the theory of machines.
- Q.** Is it possible to learn all of horology in the normal apprenticeship term?
- A.** Yes, if it is eight years as formerly, when masters made all kinds of watches and taught them to their pupils. However, no particular time can be specified, since it depends on disposition, taste, application and the manner of teaching.
- Q.** Do horology masters make all the parts of watches?
- A.** No. It is no longer possible to make all the parts because of the low prices at which watches are sold. You can be more industrious and achieve more when dealing with only one part. But it is advisable to know how to make all of them, because each helps with the other and they are made the better for it.
- Q.** If each master makes only part how can all be learned?
- A.** It will be necessary to follow the divisions in the factories, starting with all types of movements and wheels which will occupy three years. Finishing is learned by theory and one year of practice will be enough. During this time you will learn the ideas of repetition which you will study in your recreation time, learning the names of all the parts and their actions. Twelve kinds of repeater-work is the greatest number for the least intelligent; but I have had pupils who, in their fourth year, knew more than the majority of the country repeater-work makers, who make them without understanding the mechanism. I spend six months on casing repeaters. There remains examination and gilded assembly. This part does not require training for the intelligent workman who understands the principles of finishing and repeater-work. It is only a question of verifying the train, adjustments, the escapement and so on; to put all the parts in order after they are gilded. However, this costs much for those who do not learn according to the rules I have established.
- Q.** Of all these topics, which is the most difficult?
- A.** It cannot be disputed that repeater-work is really the scientific part of horology. Therefore it requires more theory for design and more delicacy and precision in manufacture. This is why those who know it and practise it, carry it out with more perfection than other types of work.
- Q.** Since only a little time is needed to acquire all this knowledge, why is the number of those who possess it so small?
- A.** For several reasons. It is necessary to:
- 1, have been born with the happy disposition to create;
 - 2, have a sense of taste that nothing distracts;
 - 3, be of an age where the spirit develops and impressions are strongest; and
 - 4, have masters who have all the talents that I characterised and who will sacrifice time for teaching.
- The great majority cannot do this since, on the contrary, impatience to earn money prevents them from completing their training.
- Q.** Wouldn't the way be to go to public schools?
- A.** Yes; it would be very advantageous for horology if dedicated young people learnt the mechanics taught there. They have courses on all aspects for those who are already dedicated, workshops in which to work while learning, and where the craftsmen could display their productions.
- Q.** Where is it necessary to start learning about horology?
- A.** Before studying any of the areas it is appropriate to learn the names of tools, their use and the manner of using them, the names of the parts and their actions, to learn by heart the definitions of the terms placed at the beginning of this book; this will be of great use to masters as well as pupils. When you are familiar with tools and can file and turn, you will have the movement of a simple watch explained by calibres, according to the intelligence of the pupil.
- Q.** What is the surest and quickest way to make a simple watch movement?
- A.** I said that I engaged in this course of lessons only to treat repeaters in all their aspects.
- Q.** What other means are there to learn this first part, which is the base and foundation of the edifice?
- A.** Nothing is easier nor more common, as all masters teach it and there are several excellent treatises which omit nothing. This is why I will not say any more on it in order to give more time to repeaters

which have never been treated and which are little understood, although it is important to understand them well because many work on them⁴⁵.

- Q.** Which books treat horology? Why is it that few horologists have them?
- A.** Several erudite books were printed in Paris, but the treatises of Thiout the elder, Berthoud and Lepaute are esteemed. The excessive price of these books prevents the majority of workmen from getting them.
- Q.** Isn't this rather because these books are not within the range of the ordinary workmen, by which I mean that many workmen cannot understand anything in them?
- A.** It is true that these men wrote more for scientists and it is necessary to educate the ignorant who form the majority. As very few can read and understand the descriptions, all the terms of which are unknown to them, it is only those who have studied mechanics who can benefit from them; and they are so few that only one in a hundred bother with them.
- Q.** Why didn't these authors think of giving more help to workmen to understand the beautiful things about which they wrote?
- A.** Because to deserve the title of scientist it is necessary to write as a scientist, which is not appropriate for illiterate workmen.
- Q.** It seems that these authors wrote mainly to make themselves known, by devoting their books to scientists and amateurs. Wouldn't it also be possible to write for workmen?
- A.** I believe that a book in the form of a conversation with workmen, such as this one, will be more useful. Besides, it is a collection of existing facts gleaned from long practice, and they should be within the powers of workmen in all workshops, which to some degree they are.
- Q.** The authors who wrote on horology, didn't they include repeater-work?
- A.** They wrote about it only historically, but it is the study of practice which is needed for the many watch-makers who work on repeaters without knowledge. Anyway, it is a new part invented recently, and it so extensively occupies many workmen that it is only by improving it that it will be propagated.

⁴⁵ I think the best contemporary description of making a simple verge watch is Ferdinand Berthoud and Jacob Auch: *How to make a verge watch*.

Lesson 4 - Construction of repeater-work

Repeater-work

Question What is dial-work?

Answer This name is given to all the parts that are placed between the dial and the pillar plate, and it is from the dial that they draw their name. But it refers particularly to the parts for repetition, repeater-work.

Q. Are there several kinds of dial-work?

A. There are as many as there are different movements, and they depend on the various functions of the watches.

Q. Which are principal or generally known ones?

A. They are those of repeater watches, placed under the dial in a frame or false plate which forms a circular collar for the dial and which is held onto the plate by three key-screws. This dial-work frame contains all the parts which cause the hours and quarters to strike, except the hammers which are placed in the frame of the movement.⁴⁶

Q. Are all repeater-works the same?

A. There is no other part in horology which varies so much, in its principles as well as in its execution, because there are no general rules or a calibre to be followed like we have for movements. All the positions are so arbitrary that even a workman who makes nothing else will not be able to guarantee to make two exactly the same.

Q. Why does this variation occur?

A. Because the shape and position of the pieces can be changed. Workmen avail themselves of this to arrange their work to the greatest advantage.

Q. Are there no general rules that everyone can follow?

A. Yes, up to a certain point. But if the arrangement of the train is varied we are obliged to conform to it.

Q. What are the general rules that any repeater-work maker must know, and what is the basis of good repeater-work?

A. The rules are to lay out the calibre so that

- 1, all the parts need little force to perform their functions energetically and strongly;
- 2, the push-piece is not, at the same time, long and hard to push; and
- 3, each piece performs its particular action without being obstructed by others.

To understand this ingenious work it is advisable to go into the details of its execution, as I will now.

Tracing the calibre

Q. Aren't there calibres to follow, as there are for movements?

A. No, because we are obliged to conform to the layout of the train; that is why we cannot use other calibres⁴⁷. It is necessary to combine repeater-work with the train by starting with the hammers, which will be placed as far inside as possible without obstructing the rotation of the wheels which surround them. Then the slot, or recess, for the push-piece will be marked between the fusee wheel and the barrel so that it overlaps neither one nor the other, and this entry will be the position of mid-day. Also it will be the middle of the hinge and of the winding-rack or the support for the push-piece. The position of the pivot-point of the winding-rack, which is arbitrary, will partly decide how far and how easily the push-piece is moved; because the further the pivot-point is from the point of support, the longer and easier the movement. The pulleys, which are traced next, also affect this by their size, which is also arbitrary; it is easy to understand that by acting on a larger radius the movement will be easier.⁴⁸

46 Crespe uses the term *bate* (collar) throughout and sometimes *faux cadran* (false dial). I use the term *dial-work frame*.

47 By 1800 there was considerable standardisation of verge watch movements and many repeaters, although not identical, are very similar to each other.

48 The size of the fixed pulley is arbitrary, but affects the ease of movement.

The size of the chain pulley z (Figure 5) is not arbitrary. The sizes of four pieces (the pulley diameter, the chain length, the diameter of the hour-snail, and the shape and size of the winding-rack) must be matched to each other.

The pulley z rotates half a turn to move all 12 teeth of the hour rack past the hour-pallet and its total movement must be less than one turn. Thus, if r is the radius of z on which the chain acts, the length of chain unwound has to be less than $2\pi r$. Because the movement of the winding-rack must ensure some chain remains wound on the pulley (or the chain could be broken by forcefully depressing the push-piece) I will assume $\frac{3}{4}$ of a turn is used, which is sufficient for both the hours and quarters. Consequently, the greatest distance that arm D of the winding-rack can move is $\frac{3}{2}\pi r$. Now, using the arrangement in Figures 1 and 2 where the distances from

The star-wheel carrying the hour-snail, which is the same size as the star-wheel, should be made large so that the sections are as large and solid as possible; this is limited by the square of fusee⁴⁹. The barette of the contrate wheel, the spring of the large-hammer and the star-wheel jumper are outside it. Inside it is the recess for the canon pinion carrying the collet which retains the surprise-piece. The quarter-rack, which operates the two hammers, will be placed between them, but inclining a little towards the small one. It will be as near the center of the plate as the passage of the chain will allow.

The all-or-nothing piece is traced from the center of the star-wheel to the end of its locking arm for the quarter-rack.⁵⁰ This locking arm must be longer than the other arm, which moves it by the amount of lock.⁵¹ The pivot-point of the all-or-nothing piece is fixed far enough from the fusee square so that the winding key can pass, and on a line drawn from the pivot-point of the winding-rack to that of the quarter-rack. At the same time the all-or-nothing piece is used as the star-wheel bridge.

These are the principal positions which determine the design of repeater-work, which is called *calibre tracing*.

- Q.** Isn't it important to know where to place all the other pieces, about which you have not spoken and which appear me to form the greater number?
- A.** Unless they are parts which touch other parts or are springs, we cannot make variations. A more or less long spring will function satisfactorily provided that it is in proportion with its length and has the action which it should make.
- Q.** When the calibre has been traced, which part is made first?
- A.** The dial-work frame which, as I said, forms the frame for the repeater-work and determines the shape of the case. Its height is proportioned to that of the movement and then its diameter according to the size of the case. It has a snap in which the plate enters by a third of its thickness.
- Q.** Is the dial-work frame held sufficiently to the plate by this snap?
- A.** It is also held by three screws or key-screws fixed to the plate. But before it is fixed it is necessary to turn it hollow⁵² and to fix its position relative to the opening for the hinge, whose center is the point of mid-day or sixty minutes. From this point we divide the circle of the dial-work frame into four parts which will be used to divide the quarter-snail. Then most of the bottom is removed, keeping flanges for the dial feet and the screws, and retaining the area around the hinge to preserve strength.
- Q.** But I do not see on your calibre the position of the quarter-snail, of which you have spoken and which must be of consequence since it determines the quarters.
- A.** It is there and has been ever since the origin of the movement. The first point which the train maker marks is that of center of the plate, which is also the position of this part. It is riveted onto the canon pinion, as is the surprise-piece about which I will talk later.
- Q.** Shouldn't we make these parts the first, since their position is always the same?
- A.** On the contrary, because their actions are dependent on others they must be made last.

Repeater-work frame key-screws

- Q.** Where are the key-screws placed and how are they used to hold the repeater-work frame?
- A.** We draw a concentric line on the plate, as close as possible to the edge, on which they are equidistantly placed (120° apart). The surface of the plate is turned down so that they are stopped by the step in the plate and cannot go further. Then we make hollows in the repeater-work frame collar with a (hand held) cutting tool; they are made so that when the screws are tightened their keys lock the repeater-work frame against the plate.
- Q.** Are these three keys the same?
- A.** Yes, but to identify them we mark them and the plate with guide marks. It is not advisable to interchange them as there are always some differences between them.

the pivot B of arms D and a are in a ratio of about 5:7, the distance that the winding-rack hour-snail arm a moves is in a proportion of 5:7 with respect to arm D so that the total distance it can move is $\frac{15}{14}\pi r$. As half a turn of the pulley is required for the hour rack, the distance from the outside of the hour-snail to the bottom of the XII step must be approximately $\frac{5}{7}\pi r$. This must be less than the radius of the hour-snail and Rees, in Figure 5, suggests it should be about half that; in other words, the radius of the hour-snail is roughly $\frac{10}{7}\pi r$.

In reality, as Crespe explains later, these parts are made approximately to size and then adjusted to suit.

49 Continental verge repeaters are wound through the dial.

50 The size of the quarter-rack has been basically specified by the positions of the hammers, although the length of the detent arm seems arbitrary and so this is rather vague.

51 The arm jK should be longer than jI so that a small movement of the star-wheel will produce a safe depth of lock on the quarter-rack locking-face without damaging the pivots.

52 Crespe's writing is a bit obscure when he tells us to "empty the circle"! He wants us to hollow out a disk of brass on a lathe to form a plate with a collar.

The hour-rack, hammers and lifting pallets

- Q.** Does the steel wheel which strikes the hours form part of the repeater-work?
- A.** It is a ratchet called the hour-rack. The repeater-work maker need only examine it to check the accuracy of its teeth and to make sure that there are twelve of them, neither more nor less as sometimes occurs. The teeth will have to be finished with rounded-off points, and then the hour-rack hardened and tempered and the teeth carefully polished.
- Q.** What do I have to consider in the construction of the hammers and what should be their shape?
- A.** As for the hammers, the only point is to make them as long and heavy as possible. Their shape is determined by the passage of the adjacent wheels, which they should just clear to give them more weight; because the force of the blows depends on their size. The projecting face of the hammer, which strikes the bell, must be proportioned to its weight; it would be in vain to have a heavy hammer if this part were narrow and very short, because then the hammer would give blows which are not very distinct.
- Q.** Are there rules for placing the pins on the hammers?
- A.** Undoubtedly. The large-hammer quarter lifting-pin at the end (Figure 3: 2) is most important since it strikes the quarters, but there is little room on that part of the hammer which must clear the great wheel carrying the hour-rack. The pin is put as far to the inside as possible and close to the arbor of the hammer, so that when the hammer rises (goes down into the frame) the slot for this pin does not come too close to the edge of the plate and does not go beyond the edge, as one often sees and when it then obstructs the case. On other occasions it meets the slot for the hour-pallet lifting-pin (Figure 3: 3). As for the large-hammer strike-pin (Figures 2, 3: 1) on which the spring acts, we want to place it as close to the arbor of the hammer as the quarter lifting-pin; the spring will make less way and the blows will be stronger and more distinct, which is why we will place it as near as the hour-pallet lifting-pin will permit. What I mean is, as close to the arbor and more towards the outside edge as the passage of the quarter-rack locking-face will allow. When the pin is too far from the arbor it requires the spring to be curved too much, which makes it harder to raise the hammer and makes it lose its force when the hammer arrives at the edge of the plate.
- Q.** How does the hour-rack, or ratchet, cause the large-hammer to strike?
- A.** By means of a part called the hour-pallet. It is loose on the hammer arbor and has two arms, one of which meshes with the teeth of the hour-rack and the other operates the hammer. It forces the hammer to rise until, as the hour lifting pallet escapes from each tooth, the spring returns the hammer. This repeats as many times as there are teeth or hours to be struck.
- Q.** Before making the hour-pallet, isn't it advisable to make the springs?
- A.** Yes, but only those of the two hammers.

Springs

- Q.** Do the springs require proportions which are difficult to make?
- A.** Yes. We must remember that springs are at the heart of all moving machines and they require much delicacy and attention to make well, skills which the majority of repeater-work makers do not have. The force of the repeater spring being given, it is necessary to economically use it for those forces which it must overcome, by a reduction proportional to their purposes. As the motive power of the repeater-work only exceeds this by the amount needed to drive the repeater-train, we must regulate the force of the springs for each part and make these parts so that they require just enough for their action according to this proportion.
- Q.** How many springs resist the motive power?
- A.** There are five types of them which act against it.
- Q.** What are they?
- A.** They are:
- 1, the two hammer strike-springs which are very strong to make the blows loud;
 - 2, the quarter-rack drop-spring, which must also be rather strong to overcome the springs of the quarter-pallets;
 - 3, that of the hour-pallet;
 - 4, that of the all-or-nothing piece,
- to which we must add that of the star-wheel jumper⁵³.
- Q.** These appear incomprehensible. What is the effect of this profusion?

⁵³ There are 8 springs in this list, 6 of which directly oppose the repeater spring and 2, the quarter-pallet springs, do so indirectly. The all-or-nothing piece return-spring *J* resists the locking of the quarter-rack. The star-wheel jumper-spring affects the lifting of the quarter-rack just after the hour when the surprise-piece is in action. There are 10 springs altogether; Crespe omits the two hammer counter-springs which do not oppose the repeater spring.

- A. Many horologists look at the functions of repeater-work without making this observation. All depends on knowing, as I mentioned above, how to proportion the progressive forces with the motive power; it is necessary that their actions go from strong to weak on the liftings, like the quarter-rack and so on.
- Q. I don't understand all their actions yet, and so isn't it advisable to postpone them until later?
- A. I expected you to say that, but it is important to give you the idea of them, because if the springs are done one after the other you will understand their gradual proportions better.
- Q. What steel is most suitable for making good springs?
- A. That which comes from England is the best. The parts of which it is made up are more uniform and tighter, and so we have as much force as with a third more of other steel and with less thickness.⁵⁴ Consequently the springs will be more elastic and will retain their elasticity better, especially if the blades are wide.
- Q. What shape should they have?
- A. The blade must be a whip and act over its entire length. The foot must be as solid as the space allows.
- Q. How should they be curved and placed to act uniformly?
- A. They should be placed and curved so that they make little way while functioning, so that their acting length does not vary and thus their force does not vary.
A spring that is too curved hardens its effect, prevents the pallets from escaping and loses its force when it returns to its place. It is very unsatisfactory for repeaters which act on bells.
- Q. Is there a difference between the springs for repeaters which act on bells and those which act on dumb parts?
- A. Those for repeaters which act on bells must be weaker with more curvature.⁵⁵ It is well known that a hammer spring which is too strong, striking against a bell, stops its vibrations; as I will show when speaking about sound bodies.
- Q. How are the springs fixed to the plate?
- A. By a very small foot held by a screw close to the blade so that the blade, which has a gap between it and the plate, can flex freely without the head making any movement. The lower parts which could cause friction are round off.
- Q. How are the springs hardened and what is their degree of hardness?
- A. They are hardened in oil after heating them past blue to a cherry colour. The colour to temper them must be proportional to the quality of the steel; English steel should pass blue. It is very important that they are tempered throughout their length.
- Q. How can I correct springs that are distorted by hardening?
- A. When that occurs in the height you can use a peening hammer to obliquely strike the edge which you want to adjust. If, however, you want to increase or decrease the curvature you take a rounder hammer and, resting the blade on a lead block, strike the side which you want to correct.
- Q. Aren't springs which are thin and weak likely to be burned when hardening?
- A. Yes, undoubtedly they would burn if you hardened them in the delicate state that you see them in. This is why they are left stronger (thicker), and they are weakened only after they have been hardened.

The silencer

Question What is the action of the silencer?

Answer The silencer intercepts the blows of the hammers by receiving them at its ends, and communicates them by an arm to the case where a spring with a button is fixed. By pressing a finger on this button the hours and quarters strike against the finger, so that you can tell the time when in company and you do not want them to know. It is also useful for people who are blind and deaf.

Q. How is it made?

A. It is very simple. When the two hammers are raised in the frame you fix the silencer at the edge of the pillar plate by a screw, so that it spans between the two hammers. It is as long as the distance from one hammer to the other, and each end acts on a pin of one of the hammers; on the large-hammer it lies on inside of the large-hammer quarter lifting-pin (Figure 3: 2), and on the small one it is outside the small-hammer quarter lifting-pin (Figure 2: y). By pushing the projecting arm, which is placed on the side of the small-hammer, it lets them drop, but only by a quarter of their lift. You make it stop against the spring of the small-hammer, or against a key-screw. As the large-hammer must move further, you will arrange the silencer to act on it a little before the small one. You bore a

⁵⁴ This is presumably shear-steel, made by welding pieces together by hammering; see Leonard Weiss *Watchmaking in England 1760-1820*.

⁵⁵ Crespe says "... avec plus de bande" and I presume he uses *bande* in the sense of "like the side of a ship" which aptly describes the curvature of many such springs.

hole in the case opposite the projecting arm through which you pass the button, which is held by the spring that you fix inside by a screw. This spring thus operates the silencing device when the button is pushed, and the blows are felt against the finger.⁵⁶

- Q. What is the action of the touch piece?⁵⁷
- A. It is used to make the sounding pieces have the effect of silent striking, by a small side movement that you give to it by means of an arm outside the case. Then it is presented opposite the hammers and receives the blows like the silencer; except the silencer acts at its pivot, instead of which the touch piece acts over its length. The ends are two masses which rest against the case and the blows are silent, but you can feel the strikes.⁵⁸
- Q. Does this part, being attached to the case, belong to repeater-work?
- A. No. It is entirely unknown to repeater-work makers who don't case movements. Which why I will return to its construction when I discuss assembly.
- Q. Which part does one make immediately after the touch piece?
- A. That is arbitrary. Some make the quarter-rack and others the all-or-nothing piece, but I find most make the winding-rack.

The winding-rack and its action with the pulleys

- Q. Could you describe the action of the winding-rack?
- A. It is the first part of the repeater. It acts by pressure of the hand on the push-piece and communicates that pressure to all the others; the push-piece acts on it by a small heel which is attached to it. The chain, held at one end, wraps around a pulley squared on the arbor of the hour-rack (which strikes the hours). This chain passes around another pulley close to the winding-rack to make the action easier. When the winding-rack is pushed, it pulls this chain which unwinds and makes the hour-rack retrogress as many teeth as the winding-rack is pushed. This is determined by the hour-snail with twelve steps, against which an arm extending from the center of the winding-rack rests; so that when it meets the highest step of the snail the winding-rack will make the hour-rack retrogress only one tooth, and when it meets the lowest step it will make it retrogress twelve. This movement is done by the down stroke, after which the repeater-train turns and makes the hours strike. Each time the hour-rack is moved by the winding-rack it winds the repeater spring. It is enclosed in a barrel which is fixed by two screws to the inside of the plate and through which the arbor of the hour-rack passes. The arbor has a small hook which enters a hole bored in the end of the spring, and so winds it.
- Q. A good understanding of its action is necessary for its construction. Shouldn't I start with the pulleys?
- A. The centers of the pulleys and their sizes can be fixed on the plate when tracing the calibre, and they can be adjusted to suit the winding-rack; but it is better to make them at the same time. I said that the pulley, which holds the chain and winds it, is squared onto the arbor of the hour-rack. It is clear that the smaller it is the less the winding-rack has to move to operate it, but the action of the winding-rack will be harder. So we give this pulley the right proportion between the two advantages of the action being short or easy.⁵⁹ The other pulley is used only to lead the chain and we make it larger. It must be loose on a stud in the plate, free without shake. The chain must run very freely on both pulleys. The end of the winding-rack will come close to the pulley and will hold the end of chain by a screw which enters and turns freely in a ring attached to the chain.
- Q. Does the winding-rack have a definite shape?
- A. No. For it to be excellent it should be very broad and solid. As it is the part which suffers most, it often happens that it breaks at the interior angles, where it is hollowed out; especially when the heel or point of support is on the same line as the arm which presses hard against the hour-snail. This resistance to the action of the person's hand makes it break in the angle of the two arms, or beside the hole of the screw which holds the heel when it is opposite one of the angles.
- Q. What are the proportions of the winding-rack arm for the snail, so that it meets all the steps exactly?
- A. This arm must describe part of circle whose center is the pivot-point of the winding-rack and which passes through the center of the snail. Each step of the snail must be traced on this line and it is the only proportion which is given to this part. When you have determined the path which it must traverse to release twelve teeth by a whole revolution of the hour-rack, you cut it off at that length.

56 This silencer acts on the hammer lifting pins (pins *y* and *2*). It prevents the hammers dropping fully so that the pins strike the silencer before the hammers reach the gongs. The silencer pivots where it is screwed to the plate and there must be a spring to hold it away from the lifting pins unless the button on the case is pressed.

57 The term *pulse-piece* is also used, perhaps to avoid confusion with the touch pieces of *a-tact* watches.

58 Unlike the previous silencer which prevents the hammers dropping fully, this silencer allows the hammers to drop, but they hit blocks resting against the case instead of the bell or gongs.

59 See footnote 48.

- Q.** How is this done?
- A.** It is done only when the quarter-rack is made and is called *putting the chain to length*. You start by fixing the chain to the pulley at a point which must be within the angle of two lines, one drawn from the pivot-point of the winding-rack to that of the hour-rack and the other between the outsides of the two pulleys (which indicates the path of chain); this is done at the moment when the twelfth tooth of the hour-rack has passed the pallet, so that when all the hours have struck there is still a interval for the quarters. Before the chain has filled the pulley, put on the quarter-rack with its gathering-pallet in the position where the three quarters have struck after the hours. Then cut the chain at the winding-rack so that, with the ring, it just enters the winding-rack positioned at its highest point on the plate.
- Q.** Isn't it advisable to mark on the square of the hour-rack the point for the chain?
- A.** This guide mark is useful only to those who do not know the rule that I have just established, and who are embarrassed when it is not there. That is why it is necessary to do it.
- Q.** How is the winding-rack is held in place?
- A.** By a key-screw or a bridge fixed by a screw and a foot; the latter is preferable (Figure 1: Y). It is necessary that the winding-rack is free and without shake, and especially that it is level.

The quarter-rack and its pallets

- Q.** What are the functions of the quarter-rack?
- A.** It is the part which has the most functions and its execution requires great precision:
- 1, it makes the two hammers strike;
 - 2, it causes the hour-pallet to be held away from the teeth of the hour-rack, so that the hour-rack can turn without touching them;
 - 3, it locks with the all-or-nothing piece after striking is completed; and
 - 4, it determines the number quarters by an arm which falls onto the steps of the quarter-snail.
- Q.** Isn't it advisable to make the quarter-pallets before the quarter-rack?
- A.** Definitely. For this purpose you draw lines from each hammer to the pivot-point of the quarter-rack and on them you form the pallet in the shape of a tooth so that the point lies on the line. Their length must facilitate raising the hammers, but by being long they will cause the quarter-rack to have large teeth and to traverse a greater space. Consequently the quarter-snail will be larger, which often causes problems that have to be overcome. The general rule of workmen is to make that of the large-hammer the same length as that for the hours, and that of the small-hammer should be a little shorter and more solid.
- Q.** What is the main concern in making the quarter-rack?
- A.** It must sit on the plate perfectly true and free and elevated above the base of the repeater-work frame. This is done by a canon to which the quarter-rack is threaded, and this cannon enters a stud firmly screwed into the plate. You then bring it near the pallets starting with the small-hammer, which must be raised half way before the large one moves in order that it escapes first. The width of the first tooth is determined by moving the rack back until the moment when the hammer, after escaping, returns to the edge of the plate. You then measure this distance by a tool called an *échantil-lon*⁶⁰ and form the other teeth, which must all be quite equal. When the third tooth is made, the pallet of the large-hammer fits into the quarter-rack so exactly that it seems to form a part of it. Beyond the third tooth is the arm which moves the hour-pallet out of mesh with the hour-rack teeth. A piece, somewhat longer and curved, comes off this arm for locking when the three quarters have been struck; I say longer because it must only lock with the all-or-nothing piece, and the part which moves the hour-pallet⁶¹ must not touch the all-or-nothing piece while coming and going. Next is the large arm for the snail. Its height will be determined by the distance from the pivot-point of the quarter-rack to the center of the plate, measured by a line from one center to the other; that is, it must just pass beside the center arbor. Its length will be from the pinion of the canon pinion to the passage of the pallets to the first teeth (a little less), so that the quarter-rack just drops onto the snail when the pallets have retrogressed all the teeth.⁶² This arm will be shaped so that it can fall on each step of the

60 A tooth equaliser; see Figure 16.

61 The hour-pallet locking pin 3.

62 In Figure 2, imagine *NML* to be a bar with an arm *Lc* extending from it. Because this arm is not formed as an arc of a circle Crespe explains where it *ends*. The arm for the snail needs to act radially to the quarter-snail and so he says the acting face of the arm must lie on the circumference of a circle centered at the quarter-rack pivot point and whose radius is the distance between the quarter-rack pivot point and the center of the snail. The *length* of this arm is measured along the line *Lc*. Crespe assumes the 3/4 step on the snail has the same diameter as the canon pinion, affirmed in the text at note 72. So *Lc* must be from there to where all the teeth of the rack can pass the pallet. Note that the quarter-racks in Figures 1 and 2, and on the cover, have a short section attached by a screw so that they can be adjusted.

snail without obstruction or being held by the steps of the snail. The slot for the hour-pallet will then be made, through which passes the pin which holds it back. You can give the remainder whatever shape you wish, provided you give each part a strength proportional to its purpose.

- Q.** Can I place the pins which drive it wherever I like?
- A.** On the contrary, their positions are of great significance, especially the one for the quarter-rack gathering-pallet. Many repeater-work makers put little importance on it, which results in frequent problems with striking the last quarter. This happens when the pin is too far to the front of the quarter-rack, or under the first tooth. If, on the contrary, it is too far back, or under the third tooth, the first quarter would have difficulty lifting. You should determine its position by the following rule. Put the quarter-rack in place with the pallet and mark a coloured spot so that this spot is same distance from the hour-rack square when the quarter-rack has dropped onto the three-quarter step of the snail as when it has struck and is locked; this will be about under the second tooth. In this position you are sure that the quarters will be struck with equal force. Although the pin for the drop-spring is not as significant, it should be placed according to the same rule. The purpose of the spring is to drop the quarter-rack. The position of the spring having been fixed, use a compass to draw two arcs on the edge of the quarter-rack using the screw hole of the spring for their center; one when the quarter-rack has dropped and the other when it is locked. The midpoint between these two lines will be the place for the pin.⁶³
- Q.** What would happen if it were placed, higher or lower?
- A.** If it were higher the spring would act in opposition to the quarter-rack pivot and the rack would not drop. If lower it would lose its force before the quarter-rack reached the three-quarter step of the snail, which is very often the case, and the rack drops only by the impulse of the locking-detent. But it is necessary that the quarter-rack drops on each step with the same force, which will occur if you follow the prescribed rule.
- Q.** What must be considered when making the gathering-pallet?
- A.** Firstly, that it is well squared onto the arbor of the hour-rack, that the attaching pin goes through its center, and that after the last hour has sounded there is a small gap between the quarter-rack and the pallets.⁶⁴ Also, when the quarter-rack is locked and the repeater spring has been wound a complete turn so that it is ready to strike twelve hours, make sure the back of the gathering-pallet does not rest against the pin; this would prevent the winding-rack from pushing the hour-snail to make the quarter-rack drop.⁶⁵
- Q.** What do you know of the “moving hooks” that some place on the quarter-rack to make it return?
- A.** You gain power by making it return further from its pivot-point. But these parts must be made in the right proportions, which not everyone understands; I have seen some whose action fails because they are too short or too long. A pin placed on the pulley, by gaining centrifugal force, would be preferable; but as the gathering-pallet is easier to make well, a pin positioned on the quarter-rack by following the rule must be preferred.⁶⁶

The all-or-nothing piece

Question What is the action of the all-or-nothing piece?

- A.** It has two actions and it also has two names. It is called the *all-or-nothing piece* because it locks the quarter-rack and prevents it from dropping until the moment when the winding-rack, by pushing the hour-snail, makes it move away enough to let the quarter-rack pass and strike the hours and quarters indicated by the snails. If you do not push hard enough and the winding-rack does not push the snail, the all-or-nothing piece remains locked with the quarter-rack and the train will turn without striking. It is thus rightly called the all-or-nothing piece. It is also called the *bridge* because it carries the arbor of the star-wheel and the snail, forming with the plate a kind of frame in which they are contained.
- Q.** What shape must the all-or-nothing piece have?
- A.** Some parts are determined. The holes for its arbors were fixed when we traced the calibre; one by the path of the quarter-rack locking arm, and the other by its pivot-point close to the fusee square with just enough room for the winding key. This hole is put in the rough piece, with that of star-wheel. Then it is supported on the plate by two arbors whose shoulders are high enough to hold it horizontally at the height of and level with the quarter-rack. And it is of the same thickness as the quarter-rack. Make the quarter-rack pass so that when it returns to lock, the all-or-nothing piece has the hole on this side large enough to let the quarter-rack come behind, and to retain it with precision. For this action use a compass to draw a line on each locking-face, taking the pivot-point of the all-or-

63 Obscure because the radius is not specified and I think Crespe may mean the intersection of the two arcs.

64 We want a short period of silence before the quarters sound.

65 This limits the rotation of the chain pulley z to about $\frac{7}{8}$ of a turn; see note 48.

66 I have not been able to find a description or illustration of “moving hooks”.

nothing piece as the center of movement. Then file them on this line to make the lock solid and correct; those which are not done according to this rule are prone to drop early with the least pressure.⁶⁷ That done, give the rest the shape which you want, making sure to leave it broad for solidity. As it is essential that the all-or-nothing piece cannot rise, it is held down on the pivot side by a key-screw, and on the locking side by a spring placed on it which enters a notch in a protruding stud. At the same time this spring is used to maintain locking by pushing the all-or-nothing piece back against the quarter-rack.

The star-wheel and its action with the jumper

- Q.** What is the function of the star-wheel?
- A.** The star-wheel, with twelve rays, carries with it the hour-snail with twelve steps. It is used to change the hour by means of the surprise-piece fixed onto the canon pinion. The canon pinion is carried on the extended arbor of the center wheel of the movement (called the *grande-moyenne*) in the center of the plate, and makes one revolution per hour. With each rotation of the surprise-piece, a button attached to it enters the star-wheel and advances it one ray, and consequently one step of the snail. It is retained by the jumper whose angular shape, while following the movement of star-wheel, holds it motionless during the time that it takes the surprise-piece to make its revolution, which also ensures the same hour strikes during this interval.
- Q.** What are the rules to be observed when making the star-wheel and attaching it to the snail?
- A.** It will have to be made of good brass (refined by hammering), riveted perfectly centered on a steel canon, and carefully divided into twelve equal rays. It will share with the snail all the space between the all-or-nothing piece and the plate. There must be a small gap between the snail and the star-wheel to give freedom for the arm of the winding-rack to pass to the innermost step of the snail without touching the star-wheel; and so it will be raised by a shoulder. Two screws placed diametrically between two rays will hold the star-wheel and snail firmly together. An arbor is screwed into the all-or-nothing piece on which the star-wheel and its snail turn freely and without shake.
- Q.** What could happen if this part were not firmly held?
- A.** The strong pressure of the person's hand would cause the winding-rack's arm to pass over or under the snail and break the arbor or the all-or-nothing piece.
- Q.** What prevents this happening and opposes the push of the person on such delicate parts?
- A.** I like your question because it is significant. You observe correctly that if there were not a body more solid than the arbors, which must be very fine, it could not resist for long. The canon which holds the star-wheel passes into the plate and it is there that the opposition occurs. As it is necessary that it can move, so that the all-or-nothing piece locks with the quarter-rack, the pivot hole in the plate must be opened, but only just enough to let the quarter-rack pass. Neglecting this point causes great embarrassment for examiners; who, having forgotten to check this, seek everywhere for the cause of the hours occasionally not striking after a hard push.
- Q.** I have seen jumpers of various shapes. Are there preferred designs given by rules?
- A.** Definitely. The variety demonstrates ignorance with respect to the jumper, which has to act on the star-wheel as a result of the rotation of the canon pinion and with little force. It is clear that the least obstruction or too much friction could cause the mechanism to stop completely. Therefore it is necessary that it is placed and shaped so as to act softly on the side which is pulled by the movement, and with energy on the other side to rotate the star-wheel, snail and surprise-piece. It is mounted free on a very fine stud without any shake, and the action of the jumper-spring occurs as close as possible to its pivot so that there is less resistance at the tip of the ray, passing over which often makes the watch vary or stop. The jumper-spring must be weak and very curved so that it acts softly but energetically. The spring will also have to hold the jumper so that it cannot rise; a key-screw can also be used for this purpose.

The hour-snail

- Q.** I want to know how to divide the steps of the snail. Isn't this the time to do it and what are the rules?
- A.** It is usually the last thing which is made and which masters with workmen reserve to themselves, because of the care which this task requires. Division is done by the twelve rays of the star wheel; but it is necessary that the twelve steps be in alignment with the arm of the winding-rack, which is on the plate, and with the star and the jumper. The snail is blued, so that marks will be clearly visible, and it is marked where the outside edge of the arm of the winding-rack will enter.⁶⁸ Set a compass to the distance of the pivot-point of the winding-rack so that the snail will be marked by lines concentric

⁶⁷ Baillie *Watches - their history, decoration and mechanism* is the only book I have found with a clear, if simplified, illustration of the locking.

⁶⁸ This ensures that the *end* of each step is used except when the hour changes.

with the arm. Then divide the snail by marking twelve circular lines on its other side, to cut out the steps concentrically.⁶⁹

Q. You have shown how to divide the steps of the snail. How is each step cut out? Is that done by sight?

A. When the chain has been put to length (so that it comfortably retrogresses twelve hours and the three quarters can strike correctly and freely) then the arm of the winding-rack is shortened until it is possible to release one hour with highest step of the snail. Then the second step is cut out for two hours, and so on up to twelve, testing each step. Another way is to begin by cutting out the twelfth step and then dividing all the others by sight.⁷⁰

But what is difficult is allowing the winding-rack to rise close to one o'clock without the hands stopping.⁷¹ Because, when activated at fifty-nine and a half minutes, the surprise-piece is moving the snail. It is necessary that the winding-rack can still penetrate to the bottom and that, while it strikes, the surprise-piece advances from the deepest step to present the next hour; in case you immediately activate it again, because then the hand will have arrived at sixty minutes.

The quarter-snail

Q. Does the quarter-snail differ from the hour-snail?

A. It has the same action, but because it is divided into only four parts its steps require less accuracy.

Q. How is it made?

A. The canon pinion is put friction tight on the arbor of the center wheel. Then the arm of the quarter-rack is shortened so that it rests on the pinion of the canon pinion when the two hammer pallets have dropped to the first tooth of the quarter-rack and are ready to strike three quarters. Make a notch in the pinion of the canon pinion to take the snail at the height of the quarter-rack. The diameter of the snail will be such that it will not let the pallets drop, so that the hour strikes without quarters, and with a margin for safety. It is divided into four parts by concentric lines.⁷² The three steps are cut out with sufficient depth so that the pallets drop freely, keeping a necessary safety margin so that it can never escape a tooth too many.

Q. What methods are used to accurately divide the four quarters?

A. The surest method would be the dial, but as repeater-work makers do not have it they use the repeater-work frame. Using a compass, divide the repeater-work frame into four equal parts, starting at the point of midday in the middle of the hinge. Put a temporary minute hand on the canon pinion and make the quarter-rack drop onto each step of the snail at the point marked on the repeater-work frame. However, at midday the hand will have to be past the point by about a minute in order to leave time for the surprise-piece to change the hour.⁷³

Q. As it is by the indications on the dial that the accuracy of these divisions must be regulated, are they related to those of the repeater-work maker?

A. Very rarely. The caser who fixes the dial, as well as the finisher after him, should be obliged to check them and to conform the dial to them.

The surprise-piece

Q. Please give me a description of the surprise-piece, which few horologists can explain.

A. This clever part is the last addition which is made to the repeater-work. It is used to make the hour change in an instant. If a watch is activated at fifty-nine and a half minutes it will strike the hour and three quarters; and if activated immediately afterwards it will give the next hour correctly.

Q. Before this discovery, how was this done?

A. Instead of the star wheel, the snail carried a toothed wheel that the canon pinion moved by gears. But it had a precarious moment when changing hours and the action was neither precise nor as-

69 My rough translation read "By this means all the steps will meet at the same distance. Then using the turns make, on the other side of the snail, twelve circular lines to cut out the steps concentrically." I omitted the first sentence because it is redundant. The snail is marked with arcs which are extensions of the arc of the winding-rack arm and so all arcs pass through the center of the snail. The intersections of these with the 12 equally spaced circles marks the limits of each step. Because Crespe does not explain how the turns are used I prefer to be vague and just say "divide" the snail.

70 Lecoultrre *A guide to complicated watches* has a good description of another, better method.

71 Crespe does not clearly explain this problem, but see my introduction. He actually wrote "But what is difficult is the way to return, close to twelve, exactly on the hour without losing time." Superficially this makes little sense unless I assume he is referring to the XII step and not 12 o'clock. But it is clear that Crespe is well aware of the problem as I have described it.

72 The same as the hour-snail, but using the arc of the quarter-rack arm.

73 This is superficially misleading, as I point out my description of the action of a verge repeater. However, Crespe is correct in allowing 6° of freedom and this is the reason for the following description of the surprise-piece.

sured. This led to designing a spring to make the snail move.

Q. I ardently wish to make this part. Do you believe that I will succeed?

A. You can, if you grasp the action of it and follow the rules below.

Its shape conforms to the snail. Although it is very thin you will start with rather thick steel, so that you can leave a triangular button which will enter the star wheel. Use a small canon, no larger than the innermost step, to fix it to the canon pinion at the height of the snail so that it moves freely without shake. Then, and this is the most difficult bit, drop the quarter-rack and file the front of surprise-piece until the button leads the star to the point where it will bring the jumper beyond the tip of the ray, so that when the quarter-rack returns, the surprise-piece comes out by the impulse of jumper returning to its place. To regulate its coming out, a small hole is bored through the surprise-piece and the snail. The one in the snail will carry a well riveted pin and the one in the surprise-piece is made into a slot as long as the distance it must come out. The surprise-piece will then be retained by a friction collet on the canon pinion. The surprise-piece and the snail together should be the same thickness as the arm of the quarter-rack which falls full onto both.⁷⁴

The quarter-rack spring

Q. Is the large spring (Figure 2: *f*) which drops the quarter-rack important?

A. Yes definitely, in its shape and its position. It must be placed so that it acts on the pin in a uniform way. There are some which drop the quarter-rack by one strong impulse which causes a shock, because they act in opposition to the center of the pin and they lose their force with the third quarter. It is necessary that the blade is straight when the quarter-rack has dropped half way; that is, at the second quarter. It must be fixed horizontally because it is essential that it does not press on the quarter-rack. It must have just sufficient force to work and overcome the two small quarter-pallet springs, which you will be careful to make as weak as their functions allow (Figure 2: *q, g* and Figure 7: *9, g*).⁷⁵

The fastening spring or dial spring

Q. Is the fastening spring (Figure 7: *15*) difficult to make? Why is it called the dial spring?

A. It is incorrectly called the dial spring because it is very near the dial; but because it locks the movement into the case, its name should be the fastening spring. In general, workmen fear its execution as there is little room to fix it well, because of its size. You need to keep a good head, but it must move in a slot in the plate that the hammer limits and so it cannot be as large as would be appropriate. Its sloping head protrudes from the plate for it to hook into the interior edge of the case and it has an arm which protrudes from the case the distance that the head moves. The spring is strongest of all because it acts by a person's hand. It has been noticed that the shortest are those which work best, so it must be the height of the repeater-work frame and be joined to the inside of the collar.⁷⁶

Counter-springs

Q. The counter-springs (Figure 1, 2: *i, o*) appear to me to be the last parts that are made and easy to do. Are their shapes and functions always the same?

A. Like they are done now, they are very simple. It is only a question of giving them the shape allowed by the place they occupy. What is important is that they are well fixed, strong enough not to be elastic (as some believe), and square to the pins of the hammers. It is necessary that the adjusting screws placed in the repeater-work frame are very solid, so they will not move during striking, and that they act in the middle of the counter-springs.

Hardening and straightening pieces

Q. Now that all the parts are made, teach me the best manner of hardening them. What is the most suitable degree of hardness?

A. Although I did not speak about it earlier, one must not copy those who harden them all together. The variations which hardening causes require that each part be hardened as soon as it is made and dressed to a mirror finish. Those which act with friction, like the pallets, must be hardest and be tempered to the colour of gold. The hammers, which act only by their masses and which are prone to be filed again by the examiners, will be tempered sky-blue; it is an error to leave them very hard to obtain a more beautiful polish and it is known that blue is the temper which is necessary. The quarter-rack is red at its ends, which are the rubbing parts, and blue in the center; it is the same for the all-or-nothing piece. The jumper and the two snails, purple. The surprise-piece blue, the wind-

⁷⁴ The surprise-piece is free to flop about except when it is changing the hour.

⁷⁵ Figure 7: *16* is the pallet for the large-hammer hour-pallet spring (Berthoud shows the spring itself on another plate).

⁷⁶ For details on making the dial spring and the catch see Ferdinand Berthoud and Jacob Auch: *How to make a verge watch*.

ing-rack and pulleys blue. And as for the repeater spring, it should be blue-grey.

- Q. What degree of heat should be given to have good hardening?
A. It is advisable to heat all the parts gently and very evenly until they having a cherry colour, so that they reach only the degree of hardness necessary. If they are overheated the delicate parts which make the steel are destroyed, which is called *burning*. And if hardening is repeated several times the steel loses its quality and again becomes iron.
- Q. Which is the most suitable fluid to harden parts for repeater-work?
A. Olive oil for all parts which must have elasticity, like the springs, and pure water for all other parts.
- Q. Aren't there other ways of hardening?
A. Yes. All artists who handle iron and steel have different methods according to the various kinds of work which they make; and which contribute much to their perfection.
- Q. When repeater-work parts bend during hardening, how can they be straightened?
A. In two ways. Springs which are tempered blue-grey are straightened on lead, by striking the high place which was thrown.

As for flat parts, which must have less temper, you will see by leaving them in the water if there are any which were thrown. Then you will only temper them yellow. And to straighten them you will find a sharp hammer useful, resting the parts on an anvil. The hollow side is struck and the hammer throws the two ends, so they are straightened very easily. They are then tempered a little more to the degree where they must remain. Without this precaution, the parts would again take their original curves when they are polished.⁷⁷

- Q. This instant transition of malleable steel to great hardness is for me a mystery and I would like to have an explanation.
A. It is known that heat opens the pores of steel and dilates them, and that cold condenses and tightens them. If, at the moment of greatest heat that you give it, you plunge a part into the greatest cold, it contracts and tightens the parts which make steel; so much so that not being able to support any elastic movement, they separate easily⁷⁸. Which is proven by the effect of a spring which again becomes elastic proportionally as it is heated or is tempered to blue.

Motion work

- Q. Do the two wheels, which I see, also form part of the dial-work?
A. Yes definitely, it is they which move the hour hand and which dial-work makers construct only at the last, so as not to disturb the places which each part must occupy. It is normal for the minute wheel to be placed between the winding-rack and the square of the fusee, where you must leave room for the key.
- Q. These wheels, do they have given numbers and sizes?
A. Their size is arbitrary, but normally the hour wheel is the same size as the snail and the minute wheel smaller by a third of the teeth.⁷⁹ As for their numbers, they must be such that the canon pinion which carries the minute hand makes twelve turns for one of the hour wheel on it. If the canon pinion has ten teeth and a minute wheel with thirty teeth, it makes three turns for one of this wheel. If the minute wheel has a pinion of eight driving an hour wheel with thirty-two teeth, it will make four turns for one. This, being multiplied by the first three, will give the canon pinion twelve turns for one of the hour wheel. But these numbers are arbitrary provided that they have this effect.

Functioning of the repeater-work.

- Q. Now that all the parts have been made, shouldn't I make them function as a unit before polishing them?
A. Yes undoubtedly. It will be necessary to strip the plate of all the parts and dress it well with a soft stone; the examiner should not have to improve it because of the changes that would cause. By replacing each part, you will reassure yourself of their action.
- Q. As the repeater spring powers all the repeater-work, doesn't it require great care, in its form as well as the way it acts?
A. It requires the highest care possible. You will need to be sure that its force is proportioned to that which it must overcome and that it is uniform in its thickness as well as its hardness; which one knows when it develops well spirally. It must be very free and not constrained in its barrel, it should

77 This process of re-tempering after bending was well known in the 18th century, but later writers don't seem to know about it. See also Blakey *L'art de faire les ressorts de montres suivi de la maniere de faire les petits ressorts de repetitions et les ressorts spiraux*; a translation of this appears in Wayman *The ferrous metallurgy of early clocks and watches, studies in post medieval steel*.

78 And the piece breaks.

79 Its size would be determined by using a sector.

make three and a half turns with an arbor whose diameter is a third that of the barrel, and the hook must be in the middle so that it does not cause any friction.⁸⁰

- Q.** Is it necessary to set up the spring to the third turn? And do you believe that all the parts will function without difficulties?
- A.** You see whether the first or the second turn has enough force to avoid setting it up to the third, which would not only fatigue it but the effect of the action would be too hard. As for the second question: see that the train is quite free, the strength of the hammer springs proportional to that of the mainspring, no part is obstructed by another and that the quarter-rack and pallets are free. It is also necessary to polish the rubbing parts according to their action, see that the winding-rack, pulleys and chain are not restricted in their movements, and that all unnecessary frictions are decreased or removed. If all that is observed the action is assured.

80 Spring making is described in Blakey (see note 77) and Weiss *Watch-making in England 1760-1820*.

Lesson 5 - Half-quarter repeaters and alarms

Half-quarter repeaters

- Q.** Though I have succeeded in making hour and quarter work, I am not yet satisfied. I have been told that half-quarter repeaters can be made. Could you please explain to me how this is done?
- A.** Half-quarters give more precision to a repeater; at night one can know the hour to the nearest seven and a half minutes by striking just one blow after the quarters. For example, at seven and a half minutes after the hour it will give a small blow, weaker than that of the hours.⁸¹ At twenty-two and a half minutes, a double blow for the quarter and a small blow for the half-quarter; and so on.
- Q.** What has to be added to the repeater-work for this effect?
- A.** A second quarter-rack, loose on the first, with only one tooth. This tooth is by the small-hammer⁸² and is parallel with the third tooth. When the arm which drops onto the snail is also parallel, when the snail presents the half-quarter step, the half-quarter-rack moves the space of one tooth to engage itself. For this action, one places on the opposite side a free jumper at the end of a small spring mounted on a shoulder screw, and it operates on the end of the half-quarter-rack; it is used to make it change from one tooth to another, and maintain it there.
- Q.** I do not really understand this as yet; but firstly, tell me the form of the snail.
- A.** Suppose initially an ordinary snail riveted onto the canon pinion. Another one is placed over it, attached by means of a screw, which is of the same size in all respects but divided by the half-quarters of the dial.
- When there is a half-quarter to strike, the arm of the half-quarter-rack falls onto a step of its snail, and that of the quarter-rack onto a step of the quarter-snail. Then the tooth for the half-quarter is presented after the third quarter as a fourth tooth which, after the double blow, causes only a single blow.
- Q.** I begin to understand this clever device; but I must ask what makes the half-quarter-rack act, to drop onto its snail and strike its blow?
- A.** The same agents for the quarter-rack are also used by the half-quarter-rack. The quarter-rack drop-spring causes both of them to drop, and the quarter-rack gathering-pallet, which raises the quarter-rack to make it strike, also raises the half-quarter-rack by means of the pin against which it is stopped⁸³, by a notch as long as the interval of one tooth to another.
- Q.** Can this be adapted, without difficulty, to an existing quarter repeater?
- A.** I did it several times. It is not absolutely necessary to have enough height under the dial, to make another quarter-pallet for the small-hammer, which rises to the half-quarter-rack. Sometimes the quarter-rack is so cut away, that it is not possible to mount the jumper and its spring; it is then necessary to make another rack. But the surprise-piece is the most difficult, because it must have a raised edge to reach the second snail of the half-quarters. Otherwise its action is normal.

Dial-work for alarms

- Q.** Give me a description of dial-work for alarms.
- A.** Alarm watches are arranged to make a noise capable of waking, by one or two hammers put in the movement. These are restrained until the time determined by a pointer on the dial, which is linked to a detent locking the train and which releases it at the time indicated. It then strikes until the spring is entirely exhausted.
- Q.** What is the link between the alarm pointer and the detent?
- A.** The detent is a part with two arms, attached to the plate by a shoulder screw. One of the arms stops the hammer by a small pin which goes through the plate. The other rests on a disk whose cannon is mounted friction tight on that of the hour wheel; consequently it makes one turn in twelve hours. During the time that the arm is pressed against the edge of the disk by a spring, the hammer cannot strike, being retained by the other end. But when this arm enters a notch made in the disk, then the other arm moves away from the hammer and leaves it free to strike. Now let us look at the relationship with the dial. Some mark twelve figures on the main dial, and place a pointer on the disk of the detent; others make a small dial which carries the twelve figures. One or the other is fixed directly on the canon of the disk, which turns, as I said, with the motion work. If a small dial is used, it is necessary for the notch in the disk to be presented to the arm at the moment when the figure twelve of the small dial is in line with the six hour of the main dial.⁸⁴ Thus, each time the small dial makes

81 Much of Crespe's explanation is in the context of a repeater with a single bell, and the distinction between the strikes is by their strength and not tone. Later he discusses gongs.

82 Crespe actually refers to the large-hammer here and below, but the preceding paragraph indicates the small-hammer; either could be used, depending on the sound desired.

83 Pin 2 in Figure 12.

84 See Figure 13a which uses this method; *A* is the alarm dial and *E* is the tail of the hour hand.

a rotation, if the alarm is wound, it goes off at the time when the figure twelve is in line with the sixth hour. In this position one puts on the hour hand which has a small pointer over the twelve of the small dial, while other end will be over the twelve of the main dial: thus the alarm will be released at midday, because at that time the notch is presented at the arm. If the small dial is turned to the figure I the notch will have retrogressed one hour, and so on. Therefore one sees that, in alarm watches with a dial, it is enough to put the figure which represents the hour when one wants to wake up under the point of the hand; for at that time the hour hand arrives at the hour in question and the alarm strikes.

- Q.** Are there several ways to make alarms? Which is most advantageous?
- A.** Several methods were used to obtain a louder noise of a longer duration. It appears that the oldest are those which produce the best effects.
- Q.** To judge merit of these works and to arrive to a good execution, can you explain them.
- A.** They mainly depend on the interior and it is a matter of laying out the train in a manner to fulfil the goal which is proposed; which is always to put a hammer or two in motion with the most force and longest duration. The earliest which were made had only one circular hammer, mounted on an arbor, which a crown wheel made move from side to side. As this escapement is very close to the motive power the wheel is worn out in a short time, even if it is of steel. You should understand, moreover, that the higher the spring the more strongly it will strike; and the longer it is the greater the duration. For example, if the first wheel has 42 teeth and it makes 3 turns; the second 28 teeth with a pinion of 8; the third 24 with a pinion of 6; the crown wheel 7. Then it will strike four thousand two hundred blows and will last one minute. You will use as large and heavy a hammer as the space will allow. It will be placed in the frame vertical to the crown wheel, so that its action is always even and without drop. The pivots of each wheel must be proportioned to the force which acts on them, without which the train would be destroyed in little time. A small pin is placed close to the center of the hammer and which will go through the plate, establishing the path which it must traverse by an opening which is concentric to the center of the hammer. It is retained by means of a small forked spring, which gives the impulse to the hammer, and is used as a counter-spring so that the hammer does not approach the bell by itself. This pin is also used to stop the alarm by the action of the detent, as we saw at the beginning of this lesson.⁸⁵

Alarm with two hammers

Alarms with two hammers are more popular than the previous; they are more pleasant because of the uniformity of the blows of hammers. I know of ones which have two gongs in accord and it was noticed that this consonant harmony tended to put to sleep rather than to wake up; which made me think of another, about which I will speak later.

The arrangement is nearly the same as the train for a repeater. The second wheel has a prolonged pivot which carries, on the outside of the plate, a steel ratchet wheel, of which the number of teeth is arbitrary and is made to suit the speed which one wants to give to the blows hammers. You will also understand that the smaller it is the fewer the teeth, but it will act with more force on the pallets. Let us suppose it has 20 teeth, and the first wheel makes four turns; it will give 640 blows in one minute.⁸⁶ The following numbers are the most common: the first wheel has 40 teeth, the second 36 with a pinion of 10, because of the ratchet which its pivot carries, the third 30 and pinion of 6, the fourth 26 and pinion of 6; the fifth 24 and pinion of 6, and the delay or fly 6. Then the delay will make 6840 turns.⁸⁷ The result is that this type strikes more distinct blows of a longer duration. It is made so that the hammers are equal in force and placed at same distance from the ratchet. The smaller the teeth the closer it will be necessary to have the hammers so that the levers make them rise sufficiently without being hindered by the following teeth. The pallets are laid out so that that they act alternately and when one escapes the other is starting to rise. Both springs being in action at the same time, they will have to be weaker than with repeaters, with more curvature.

However, here the counter-springs must be a little elastic, so that the hammers receive a reaction from them which will hold them further away from the bell, to let its vibrations circulate.

As for the driving spring, it determines the force of the hammer blows and their duration. Consequently

85 See Figure 13c. Berthoud's alarm (described in the introduction) is basically the same as the one outlined by Crespe. Crespe uses a single pin, acting in a forked spring, to act both with the detent and to control the hammer. In contrast, Berthoud uses two separate arms. The hammer is held by the detent *f* using the fork at *d*, and the arm *bx* controls the hammer.

86 This is correct if the second wheel has a pinion of 10 (as specified in the next sentence) and each tooth is used twice, once for each hammer.

87 This doesn't add up; for the train given the fly makes 2080 turns for each rotation of the first wheel. I presume *la première roue fasse quatre jours* is an error and 3 turns are meant. In which case the total is 6240 and 6840 is probably a printer's error.

one must aim at a calibre as high and large as possible. It is necessary that it makes four turns, and that there is an extra half turn, as much to avoid overstraining its curvature as for the stop which must be made suddenly before the last blows, which would be unpleasant if one let it entirely run out.

Q. How is this stop made?

A. The square of the winder has a small arm on it which, with each turn, passes the teeth of a small steel wheel, placed very close and held by a light friction; and on the fourth turn, there being no space, the arm stops. In the same way, while unwinding to strike, the same teeth are re-used while retrogressing and the arm is stopped. This wheel will thus have three teeth and four spaces. It can be held by an elastic steel bridge; but it is better to make three other star teeth on the opposite side, on which a jumper-spring acts and which will keep it engaged with the arm.⁸⁸

At the end of this lesson I will explain the various forms of detents which allow alarms to act at will. While waiting I will give you a description of a third type of alarm which does not have the disadvantages of the previous, namely: the first can wear itself out easily and involves much work because it occupies a lot of space between the plates; and the second tends to put to sleep rather than wake up because of its slowness and uniformity. It has been noticed that the first blows wake up and consequently they must be prompt and strong; which cannot be the case when the hammers are far from the motive power. This type has only two wheels, the second of which operates the hammer by a lever escapement, which, although it gives 1248 blows, runs faster than the others. But because its effect is so prompt it never fails to wake up, even at a great distance. It has, moreover, the advantage of occupying less space and can even be adapted to existing watches.

I drew this idea from the alarms of pendulum clocks, and I do not believe anybody before me has thought of applying it to watches. It is sufficiently generally understood, and I will show you how it is made.

Alarm with a hammer using a lever escapement

The first wheel is raised by a third in the frame, to make room under it for the hammer. The remaining space is for the barrel; as it requires less force than the previous ones, one is not so constrained by its height and it can make more turns. This wheel has 42 teeth. It drives a pinion of 7 which carries the escape wheel with 26 ratchet teeth, which acts on the anchor which in turn carries the hammer. This gives, supposing four turns of the first wheel, 1248 blows. When the barrel can be made large it can have six turns, because a weak spring is needed, and consequently this will increase the number of hammer blows. The escape wheel ratchet goes over the first wheel, or if one wants under. But if one is constrained for space inside the frame, it is placed on the outside of the plate on an extended pivot of the pinion of 7. In this case the arbor which carries the hammer will also have a prolonged pivot, on which the small anchor is put; the ratchet operates on this anchor. Then only the first wheel and its barrel remain in the frame, which occupy very little space because the hammer passes between the wheels.⁸⁹

Various detents for alarms

This name is given to the pieces which arrest a wheel and let it escape at the indication set by the dial; however, we distinguish between detents and rocking bars. The first are those which act on a disk carried on the hour wheel and on which is fixed a small dial, as I explained it above. But when a simple pointer is preferred, which uses the ordinary figures of the hours for the alarm, then the detent is called a rocker and its effect is different, as we will see⁹⁰.

The alarm hand is on a separate canon mounted friction tight on the dial; a groove is made in the canon level with the underneath of the dial, in which passes a thin steel key to retain it.⁹¹ Above and parallel to the pointer, a hole or a notch is made and a pin fixed to the hour hand enters it when the hand aligns with the alarm pointer. The rocker is a long steel piece in the shape of lever, which tilts up and down like a sea-saw, placed on the plate in a straight line.⁹² It is held by a pin in a notched stud and there is a small spring to operate it. One end is used to arrest the hammer, if there is only one of them, or the train if there are two hammers. The other end is pressed gently on the hour wheel by the small rocker spring. In this state, the hammer or the train must be free.⁹³ But when the hour hand is positioned so that its pin enters in the notch of the alarm pointer and one turns the hand nor-

88 See Figure 13c A, F and G. This is just the common Geneva stop-work.

89 This is similar to the alarm of Berrollas described in Rees: *The cyclopaedia or universal dictionary of arts, sciences, and literature*.

90 See the alarm of Lepaute described in the introduction. Crespe's explanation is better.

91 Presumably U shaped to go around the canon pinion.

92 Radially.

93 The hands are aligned.

mally, then the pin on the hour hand leaves notch, the hand rises, and it lifts the hour wheel with it. This causes the hammer side of the rocker to drop and arrest the alarm during all the time that the hour hand does not meet the notch; into which it always enters promptly under the force of the small spring. Thus, every time the two hands align the alarm sounds. One cannot mistake the indication, since on turning the alarm pointer to the left, to the hour one wants to be woken, it will not fail in its action when hour hand arrives there⁹⁴.

The same effect can also be achieved by a contrary movement. The rocker, instead of pressing on the hour wheel to lower it, is in the shape of fork with two arms and goes underneath, holding it up. This wheel carries a button. A disk is attached under the dial to hold the alarm pointer, like I described, with a hole in it. Into this hole the button on the hour wheel is pushed rapidly, being pressed by the rocker spring. Then the wheel rises and releases the alarm train or the hammer, which must be retained when the wheel is lowered. You put the hour hand over the alarm pointer at the moment when the button enters the hole in the disk and the alarm sounds. Then, while turning the hands, you will see the hour hand drop, locking the alarm until the determined hour, as before, when the button entering the hole will release the train.⁹⁵

Many people prefer this method because there is less friction when the hour hand is always lowered until the moment when the alarm rings than when it is raised until the hour. However, all is hidden and if some problem prevents the wheel from rising one is often troubled finding the cause of it. Whereas with the previous method all the mystery is exposed and anyone can easily make it function.

Minute alarms

Q. I understand all these actions very well, but let me make a request that perhaps nobody has made. Why not make alarms accurate to minutes? There could be cases where this precision would be necessary, so would it be possible to make one?

A. It is true that no-one asks for it, or that those to whom requests are made put too much importance on it and set the price too high. However, the difficulties are not insurmountable, as you will see by the following explanation.

We saw that alarms with a detent have a small dial divided into twelve parts, carried by a canon with a disk, put friction tight on that of the hour wheel; that this disk has a notch in which the detent enters to let off the hammer.

In the same way, you put on the minute canon a dial plate, which carries a small dial where sixty minutes are engraved. The detent will have two arms, one of which will relate to the hour disk and the other to that of the minutes. Consequently it cannot fall to let off the hammer unless the two notches of the two disks are presented. When you want to make the alarm sound, you place under the tail of the minute hand the minute at which one wants to be awakened. For example, if four hours and ten minutes is wanted, the figure 4 is turned to the tail of the hour hand and then the figure 10 of the small dial to under the tail of the minute hand. The alarm will sound at the indications, without it being able to deviate; you can see easily that the detent can only fall when the two notches are presented; that occurs when the figure 6 meets with the 30 minutes at midday.⁹⁶

94 Because of the shape of the notch, the alarm hand can only be rotated one way. Turning the other way will cause the pin on the hour hand to jam against the side of the notch and force the hour hand round on its canon.

95 This is the method used by Berrollas alarm described by Rees: *The cyclopaedia or universal dictionary of arts, sciences, and literature*. However, that mechanism uses a train linked to the pendant to set the alarm pointer; consequently its canon is loose on the hour hand canon and the setting train provides the necessary friction.

96 As noted before, a normal alarm can sound at any time by placing the alarm time indicator between hours; however, it is not very accurate. It is difficult to make sense of the description of a minute alarm. It is possible to have two concentric alarm dials friction tight on their respective canons. The minute alarm canon, on the normal canon pinion, would require a notched disk for the detent below the hour wheel and its disk, and a dial above the hour hand and under the minute hand (presumably squared onto the canon). The notch in the hour disk *p* (Figure 13c) would have to be one hour wide to allow its detent to function at any time during the hour, and notch in the minute disk would have to be as narrow as possible; this is because these two disks are not geared together, creating considerable ambiguity about their setting. For example, to set such an alarm to 2:30 it is possible to set the hour indicator to anywhere between 2 and 3, although I expect most users would set it approximately half way between.

I have never come across a reference to (let alone an illustration of) such an alarm. I suspect Crespe is imagining the form such an alarm might take without being fully aware of the practical problems.

Part 2 - Casing

Lesson 6 - Setting up repeater-work with bells and gongs

Question. How is repeater work set up so that the sounds are as harmonious as possible?

Answer. The train and the repeater-work being laid out according to the rules which I have specified, the first object will be to choose a good bell. Its size and height are such that one does not need remove any of it; because matter produces sounds proportional with its form, so that one cannot remove some without degrading its vibrations.

Q. How is the size and the height of the bell determined?

A. The interior size is measured so that the pillar plate just enters it, and the height should be enough for the frame with the cock, observing that the edge of the bell does not completely come down to join that of the pillar plate. But both are arbitrary.

Q. How is that?

A. Because sometimes the pillar plate is too small and there are parts which overflow it; like the barrel, the great wheel, the contrate wheel, the wheel of the strike train, the pallets, etc. These parts would touch the bell if it were close to the plate; and when one is not constrained by the shape of the case and one wants a repeater that sounds good, it is necessary that the train is free inside. It is the same for the height. So you can see that if the size and height of the bell are greater the better it will produce sounds.

Q. Before leaving this topic of the bell, could you describe sound bodies and explain to me what matter creates pleasant sounds, on what they depend and how they are transmitted to us?

A. I should send you to lessons on experimental physics; but as I committed myself explaining to you all that relates to repeaters, I will teach you what I know of sound bodies.

Definition of sound bodies

Sound bodies are those bodies whose sounds (after the strike or friction which gives birth to them) are distinct, can be compared and are of some duration.

If the matter of a bell is not porous, all the concentric circumferences which make the width of a ring and which make the thickness of the bell, would be as many complete lines. When one strikes the outside edge of a bell which is an elastic ring without interruption, all the parts which make it up and are like many small springs, are put into motion and make vibrations which agitate the air which surrounds them; and so make us perceive them. However, these vibrations would produce a complete silence if there were not between the bell and us some matter able to receive and transmit this type of movement. It is the air, agitated by these quivering parts, to which the sound must be attributed.

Q. Why, for example, are bells made of a composite metal, and what is the composition?

A. It is that any composite metal is harder, stiffer and consequently more elastic than the simple metals which enter the mixture; and sound bodies are better as their parts have more spring. One alloys the matter for a bell to draw more sound from it; without this alloy no metal would produce sounds.

Q. Are there rules which show how to select several bells which have different tones for the chimes of watches or clocks?

A. When one must link bells of several tones of, their accord is nothing other than the different ratios of the numbers of vibrations between them. Since I know that an octave means that at all the times there are two vibrations against one, a fifth when there are three against two, etc., I can safely deduce these number ratios from the accords which I hear. Thus, when my two bells are in unison it is certain that their vibrations are equal, and the same when they agree to an octave or fifth etc. So one sees that by regulating the size and the height of bells, one will have agreements which depend primarily on proportions, when the diameter of one is with that of the other as three is to two.

Q. Also explain to me why the least crack of a bell stops their vibrations?

A. A split bell cannot continue to vibrate, because the edges of the crack clash mutually and do, one to the other, what a foreign body which touches the bell would do. The sound would be stopped less if, instead of having a simple crack, it is half open along its length to the thickness. In such a case, by filling the slit with tin solder one will again give a path to the vibrations of the bell; I often found this worked for me when the crack was in the middle.

Placing the bell in the case

Q. What is required for the shape of the bell and for placing it in the case so that it produces the most sound?

A. It is necessary that the bell is perfectly uniform in its thickness on the sides of the rim; that is, there is not more matter on one side than the other. Without this the vibrations are stopped by the inequalities and cannot be propagated.

I believe I have sufficiently shown the effect of sound bodies, so that those who need to put them to use can do so with all possible advantage. Especially in repeater watches, where the bells can occupy

only a very small space and where, consequently, one must take the greatest care to make the most of all that can contribute to getting the most sound from striking watches. To do this successfully, the following points should be observed:

The space inside the case contains a volume of air which one can call the sound part. It is absolutely necessary that it has space and holes to communicate the vibrations of the bell to the surrounding air. It is absurd to require sounds from a piece that is closely confined and contained in a very strong case. The following comparison will be enough to prove it.

A man inside a room will be heard according as the room is more or less large; the shock of his voice striking a greater volume of air will communicate it with more force to a greater extent. But if the walls are thick, the air, having more trouble crossing them, will communicate the voice less to the outside. This last example must be applied not only to too small cases, but to those which are thick and must necessarily be larger, because of their thickness. The shape of cases and the manner of forging, soldering and assembling them is of great importance for the perfection of the striking watches. You will see in the following lesson what care workmen must take with this part, according to the best authors.

Q. Are there other considerations which depend on the casing and which also contribute to make repeaters sound good?

A. First, since the sound of a bell suddenly ceases by touching some other body, by stopping the vibrations, you see how the caser must be attentive to keep away all the parts which he places in the case, including the repeater-work which is near the inside of the bell.

Second, the bell has to be seated exactly in the middle of the case and made horizontal. It is an error to believe, like some people, that the seat of the bell in the case and the screw which holds it must be very small. It is better, on the contrary, that both are strong, so that the bell being seated cannot make any movement which prejudices its vibrations.

Third, hammers which have a broad surface intercept the vibrations, in that they prevent air from moving around the bell and compress it. Moreover the strike is done too low; it should be done near the edge of the rim, the depth of a ligne or more for the large-hammer and a half a ligne for the small one.

Fourth, the point of contact of the hammers should not be too broad, because they absorb the sound; if they are too narrow, they do not express it enough. Their width must be the thickness of the bell and they should be rounded so that they touch only in the middle.

Fifth, the counter-springs must be thick and firmly set, in order to resist the action of the hammers. Sixth, the flexible and elastic springs, moving approximately straight at their extremity, must have good tension without being too thick.

Seventh, the teeth of the parts which raise the hammers, must have enough distance between them so that the pallets, while traversing a large space with the hammers, can never drop onto the following teeth. On the contrary, it is necessary to leave them a little room so that they are not retained at the time they are under the effect of the counter-springs.

The best forms for cases

I will finish this lesson by observing that this matter should be treated completely, because it is entirely ignored by watchmakers, and there is no description of it in horological treatises⁹⁷. I will explain the suitable forms for cases and what is the best form for cases to make repeater watches more sonorous.

Q. Does the shape of the case for a repeater contribute to making the sound harmonious?

A. No matter what diligence the watchmaker takes in laying out for good sounds, he cannot succeed without the concurrence of the case maker, and he probably doesn't make the principal part of it. The small ones for repeaters which are meant to sound distinctly, prove the ignorance which reigns in this respect.

Q. How is that?

A. Because one commonly sees cases intended for dumb repeaters made as one needs them for those with bells, and vice-versa. This proves how much the rules vary and the little care which is taken to make the cases.

Q. What are the principal considerations which case making requires?

A. First, it is necessary that the plate from which one makes the bottom of the case is well forged. Second, that its curve is in conformity with that of the bell, so that they imperceptibly separate from each other; since when the case is too round and the bell flat, the base of the bell approaches too near the case, and compresses the vibrations in the center.

⁹⁷ As far as I know, there is no book on case making. The only useful information I have found is in Priestley *Watch case makers of England, a history and register of gold and silver watch case makers of England, 1720-1920*.

Third, lumps of unequal soldering hinder the circulation air, which transmits the sounds to us, and causes short and slow vibrations.

Fourth, the form of the bottom being as I described, it need not have too much depth. It is better that the bell has play around the rim than at the bottom; its vibrations are done only around the rim and, moreover, the form will be more advantageous. One commonly sees cases which are very tight on the sides and have excessive depth for the bell, and do not sound well.

- Q.** Don't the case makers give cases the shapes one asks for?
- A.** That is not always done, nor with enough attention. They incline rather to the form which gives them less trouble and which is what I have just described. Moreover, manufacturers believe their watches have more appeal if they appear tight and small. I am persuaded, when one compares them to each other, that everybody would prefer a good sounding repeater which is a little larger than another which has a feeble sound.
- Q.** Are there other sound bodies applicable to striking watches, instead of the bell of which you speak, which occupy less space in cases that one would like to make smaller and lighter?⁹⁸
- A.** Your question is not new and it has often been put to me. Here are the experiments I have made in this respect. I said that all the bodies made up of tight and elastic parts could produce sounds by the vibrations to which they are susceptible. Steel is of this kind, when it is pure and drawn out into blades able to vibrate. It has, moreover, the advantage that, being able to use several blades, one can have different harmonic tones for the quarters, forming a third, major rather than minor. But recalling what you know of bells, the more they have of the specific matter the more they produce sounds, one cannot expect that very thin steel blades will give such strong vibrations; however they are enough to be heard very distinctly throughout an ordinary room.
- Q.** This interests me; describe how it is done?
- A.** I will not talk about the various tests which did not produce the effect that I wanted. Like putting the blades on the inside of the case; which, like oversize bells, means that the vibrations are cut off and merged with the interior air, instead of with the outside which transmits the sound to our ears. But blades placed on the edge of the plate or the repeater-work frame, extremely close to the hammers, whose points of contact must be finished to a point in order to penetrate the blades, because of their delicacy, while striking close to their centers. These blades must be circular as the rim of bells, so that the vibrations are prolonged along their lengths. They are held firmly by a head fixed by two screws. The blade for the large-hammer will be very long around the plate, and as wide as possible; it will form the main tone of *C*. That for the small-hammer, which one wants two tones higher forming an accord, the tone of *E*, its blade will be a little thicker, finished like a whip. If the tone is too high, one will reduce it close to its center, until one has perfect accord.
- Q.** What is the precise thickness which these blades must have, and is it appropriate that they are hardened by tempering?
- A.** To answer this question, it is first necessary to observe the force of the hammer blows; because the more they have weight and force the thicker the blades must be, thinning until they are able to vibrate. The average have approximately the thickness of a good card. As for hardening, it plays a most important role by tightening the parts which form the steel, makes them homogeneous and gives them the elasticity which forms the vibrations, which is not the least difficult. Because if the blades are not heated and hardened equally, the vibrations will be stopped, and produce a weak and unpleasant quivering. In the same way, if they are overheated or heated several times, the steel loses its flogistic and consequently its elasticity. For this one must heat it to a cherry colour, not with a blowtorch which is too penetrating, but on tender and well crushed coals like large springs. One will then temper them to a good purple. It is also advisable to polish them before tempering.
- Q.** Could I know what led to the application of these blades in substitution for bells?
- A.** I will not hide from you what led me to these various experiments. It was considering the small iron instruments carrying an elastic steel blade, that children hold in their mouths and produce quite strong sounds. Using a mirror I saw that this blade made vibrations which, agitating the air inside the mouth (similar to a watch case), became sound by reaction with the surrounding air, and acquired more or less power according to the thickness, width and hardness of the blade. I promptly made several kinds of them, and I managed to produce harmonious sounds from some. Finally, I made some different blades in the same form, and I obtained accords by which I could play distinct tunes. This led me to adapt them to striking watches; and as this use is now widely followed, I am not annoyed by you wanting a little more description.⁹⁹

98 Throughout the following I have retained Crespe's word *blade* instead of using *gong*.

99 Crespe's claim to have invented gongs is mentioned in Patrizzi *Dictionnaire des horlogers genevois*. Breguet is also credited with this invention, but I have seen no evidence to support this claim.

Lesson 7 - Casing repeaters with a bell

- Q.** What does the part of repeater-work called casing consist of?
- A.** Casing consists of placing all the parts in the case, making them open and close with the fastening spring push-piece (Figure 7: 15), etc. But joined to this is a more difficult task, that of finishing the repeater-work. Consequently, to carry out this work it is necessary to be accomplished in the actions of repeater-work, as we will see in the following lessons.
- Q.** In what state is a repeater when it is given to the caser?
- A.** The train and the repeater-work must be finished. And it should be assembled, whereas some supply them in pieces, often even in bad condition. The case is unfinished and contains the frame and the bell.
- Q.** What are the main considerations for casing?
- A.** First, it is necessary to examine whether the case is quite in conformity with the piece to be put in it. Second, to check that it has a suitable height and size so that the bell has the necessary freedom to sound well. Third, to see that the repeater-work frame is not too weak and that it enters solidly in the case. Fourth, to ensure the bottom of the case is in conformity with the bell etc. When there are any of these defects, it is necessary to have them rectified before casing.
- Q.** Does the caser fit the canon for the push-piece and the cushion which carries the bell?¹⁰⁰
- A.** Yes, he always starts there, but he is often constrained at this significant point by the use already made of it by the case maker; there is the danger of unfixing or ruining the inlaid parts called *bosses*, which are placed around the canon.
- Q.** What rules must be observed when fixing the push-piece canon?
- A.** The top of the hole through which the push-piece passes must be level with the horizontal surface of the repeater-work frame. If it were lower it would not push the winding-rack on the line of the centers and would break it. Or, at the least, it would be strongly checked against its key, which would cause serious consequences for the repeater-work.
- Q.** Is the canon soldered to the repeater-work frame or the case, since these two parts are separate?
- A.** Because of this separation, one joins it to the repeater-work frame (as shown in Figures 1 and 2). When one fixes it to the case it is necessary to open the repeater-work frame for the passage of the canon, which disorders it and makes it very weak.¹⁰¹
- Q.** What length must the canon have?
- A.** It is measured by the depth pushed into the repeater-work, by means of a graduated tool. For this the winding-rack is put on the plate with the hour ratchet, the large-hammer with its pallets, and then the quarter-rack held by a finger. Then the winding-rack is pushed by the graduated tool to the twelfth step of the snail or, which is the same thing, the ratchet retrogress to the twelfth tooth. Then the distance of pushing is easily measured with the gauge and, as it is necessary that the push-piece occupies part of the canon as well as the plate, it will be left half a ligne longer. After having carefully reamed the hole cylindrical, it is inset into the repeater-work frame by half the width of its plate, and at the height which I have stipulated. Using an iron support which passes through the hole, it is bound with fine wire and soldered, making sure that it is quite square. One will also take the center of the case and solder to it the cushion which carries the bell, after having set it at the required height and having tapped it.
- Q.** I find it strange that this cushion is bored, tapped and placed in the middle of the case without the case being pierced. How is this done?
- A.** When it is correctly turned circular, it is adjusted squarely with the bell. In this state it is placed in the center of the case, on which one marks a small point so that a circle a little larger than the cushion can be drawn with a compass; this serves as a guide to hold it in the middle. The cushion is held in place by means of a steel part which crosses the case. In its center it has a screw which enters the hole of the cushion and is tightened enough for the cushion to be soldered.
- Q.** Doesn't it happen sometimes that the cushion is thrown off center by the effects of heating?
- A.** That occurs mainly with light cases which yield to the pressure of the support. It can be remedied only by pulling off the cushion; an operation which, though simple and easy, is not known to the majority of case makers, who prefer to mill them from the case.
- Q.** How is this operation done?
- A.** I said that the hole is tapped for the screw of the bell. The end of a piece of steel about 6 inches long is tapped. After having inserted it into the cushion, it is put on a fire stove which has a hole in the middle, the case resting on the fire and tongs or some other weight attached to the end of the steel rod. The square will be drawn off when the degree of heat melts the solder and, by this means, one

100 As the word *pendant* is generally understood to be a part of the case, I retain Crespe's word *canon*.

101 All the repeaters I have seen attach the canon to the case and the movement hinge is at XII. When the canon is part of the frame the movement must hinge at IX or III, as in Figure 1.

can refix it again immediately.

- Q.** Is it the same for a canon when heating has disturbed it and moved it off center?
- A.** One frequently sees repeaters having canons, push-pieces and pendant rings off center, which comes from the difficulty of rectifying them after they have been thrown by soldering. But it is ridiculous to let such deformity remain; and also surprising since we know how to resolder them easily in the same way as cushions.
- Q.** When the cushion is not very far from the center, can the bell be put in the middle of the case?
- A.** Before letting in the bell, we check the variation caused by how it is presented on the cushion. If the hole is small, it is easy to throw it to put it in the middle.¹⁰² Then a screw is very carefully made to enter the hole; but it is not cut off, because the rod it is on can be twisted in the fingers to see whether the case turns squarely. One must take care that this screw is straight and round, and a little coarse. When the cushion is thrown by the fire, the bell naturally leans. A bulls foot (or bottoming) file is used to lower the spot which makes it rise; by this means one will be able to set it right and in the middle of the case.

Continuation of casing, preparation of the hinge

- Q.** How is the hinge prepared and how is it made?
- A.** After ensuring that the repeater-work frame and the canon join well with the case, the knuckles are formed¹⁰³. To do this, put the repeater-work frame on the plate and see that it freely enters the case without being checked. Then put on the key-screws; if there are only two, it means that the spring for the small-hammer is used as a key. The key-screws must hold the repeater-work frame tightly on the plate and they must not turn beyond the center. If they turn too far or do not tighten enough, it is necessary to screw them in a turn, because it is very important that each key-screw presses the repeater-work frame against the plate.
- Q.** As the key-screws look the same can they be used indifferently, one for another?
- A.** Although they look the same, they do not stop at the correct point when used in places other than those for which they were made. This is why they should be numbered; the plate should also be numbered if this has not been done, which very often happens.
- Q.** Isn't it important that both collars join well with the dial?¹⁰⁴
- A.** Yes, so well that these three parts seem to be one; and this is done before making the hinge. Then the knuckle of the case is made, which is lowered so that there is sufficient space, as much above as below, between the bottom of the hinge that is put on the plate and the dial and the dial plate.
- Q.** When the dial plate is quite low, does enough height remain for the hinge, to form a knuckle able to support the weight of the movement?
- A.** Your remark is correct and I should have anticipated it. When the edge of the dial plate is low, there is not enough height for the knuckle which cannot be solid; because of this some split after having been used for a while. To prevent this problem, but in these situations only, the hinge can be left wider, as much above as below, and the collar notched as well as the dial plate in proportion with their strength; because it is certain that the larger the hinge the more solid it will be. It will also be necessary to make the pin enter with force and precision, so that there is friction for the whole width of the knuckle.
- Q.** How is the length of the hinge determined?
- A.** Its length is determined by the bezel after having placed the plate with the dial plate in the case. Then the bezel, which initially touches the hinge, is moved back until it can pass and close.
- Q.** Isn't boring the hole important, and how can one be caught out there?

102 Crespe uses *jeter* (throw, cast) throughout this section, meaning a movement towards or away from the correct position. Here he is suggesting drawing the hole, opening the hole on one side to shift its center.

103 The tubes through which a pin passes to form the hinge.

104 In order to be able to access the repeater-work, it is necessary that the dial can be removed or the dial and the collar can be removed together. There are at least four ways to attach the dial:

1. The dial is held in place by a screw (usually at XII) which enters a threaded hole in the false plate. The dial also has two feet which enter holes in the false plate but they are not pinned.

2. The dial has three feet which pass through the space for the repeater-work and the pillar plate, and are pinned.

3. The dial has three feet which enter holes in the false plate and are held by screws at right angles in the exposed edge of the false plate collar. This is the same as most American factory watches where the side screws are in the thickness of the pillar plate.

4. The dial is mounted on a dial plate and the bolster or collar surrounding the repeater-work is part of this dial plate (effectively turning the dial-work frame upside-down). This dial plate is then attached by screws through the side of the collar into bosses on the pillar plate.

In the first three methods the dial could be mounted on a dial plate and I presume this is why Crespe refers to *both collars*.

- A. It is the hole which decides the action of the hinge and it is bored only after having formed the knuckles, which must be as if one had turned them smooth in the turns. The hole must be placed in the middle of the hinge. A very small hole is bored from both sides, in order to be able to broach it true when the pin is put in. The higher edge of the hinge which makes the stop for it, is moved back until it opens square; making sure however that the edge of the dial does not exceed the edge of the hinge and supports it, because that would cause the dial to break. When one is so constrained, it is necessary to decrease the canon a little where the hinge stops.

The dial spring (closing spring)

- Q. How does one make the parts in the case close with precision.¹⁰⁵
- A. The dial spring has a head, which enters the plate, that is sloped so that the end starts to enter the case and then moves with a light friction until it passes the thickness of the edge of the case where it catches. But before fitting it to the case, one will adjust its movement with the plate and the repeater-work frame to make sure that, while pushing, the head remains level with the edge of the plate, in order to be able to enter and leave the case freely. Also, sometimes the push-piece touches and stops against the edge of the dial work frame before the head has reached the level of the plate. One will also ensure that the push-piece does not touch the bezel when it is closed, and that the head does not touch the bell.

Adjusting the hammers

- Q. How does one arrange the hammers to make them strike truly?
- A. After having examined the arbors, to see that they have little play and are upright, they are put by themselves in the frame to see if they are free and do not waver, and if they advance enough to the edge of the plate to touch the bell when it is in position. After having put in the springs one will see that they are held firmly on the plate and their bottoms do not touch it. It is necessary that the springs are rounded a little, of a strength proportioned with that of the repeater spring, that they have a good curve, and their effect takes place over the entire length of their blades rather than only in one place. They then should be made uniform in the shape of whip so that they have the tension necessary to make the hammers strike with force.

The counter-springs are then set up. They must be held very firmly by shoulder screws so that when tightened they cannot move by themselves. This is very important, because ordinary screws are loosened by the movement of the counter-springs and cause extremely unpleasant dissonances. It is the same for the adjusting screws which are loosened by the striking if they are too free.

To set the hammers to length for the bell, one will shorten them until the hammers return to about the edge of the plate after they strike the bell so that the vibrations are free. If they penetrate too far the blow is badly expressed. They should be cut down in a slope so that they strike only at the edge of the bell; because the more the point of contact is straight and central to hammer, more the blows are clear and harmonious.

- Q. Why are there often variations in the blows of hammers, which appear to strike the bell well at some times and not enough at other times?
- A. That comes from inequalities in the hour ratchet. Therefore one will have to carefully examine it and the pallet to see whether, while striking gently, it is possible for the hammer to return to the edge of the plate; if not the pallet should be shortened. If, on the contrary, the pallet raises the hammer only a little, and if there is too great an interval after the blow, it would be necessary to lengthen it, or to make another, so that the hammer traverses greatest possible space.

After making the large-hammer strike, the quarter-rack is put in with the quarter-rack gathering-pallet which brings it back, pinned flush with the square. After having checked that its height does not obstruct the quarter-rack, the square is cut off close to the hole, so that it will fit under the dial. Then each arbor is put in and set to height under the dial, one after the other. And after rounding them it will be seen if the parts they carry are quite free.

The touch piece

- Q. What is the effect of the touch piece?
- A. It is used to intercept the sounds of the bell at will and render the bell silent, by a small sideways movement that one gives it by means of an arm on the outside of the case, so that it moves opposite the hammers to receive their blows.
- Q. How is this part made?
- A. When the bell is fixed and the hammers are adjusted and placed by themselves in the frame, as I have shown above, one marks on the inside the positions of the ends of the two hammers, which determine the length of the touch piece. One usually makes it as a single piece, by filing the two masses

¹⁰⁵ This describes a spring and head made as a single piece, although it is vague enough to apply to both forms. See Ferdinand Berthoud and Jacob Auch: *How to make a verge watch*.

Essay on Repeater Watches

on the inside and the arm extending to the outside. It is necessary to ensure it holds firmly on the collar so that it does not make any movement by itself which could obstruct the vibrations of the bell. This is why one makes it so that it is strongly supported at both ends by attaching it with two small screws which enter slots along the length that it moves. When the hammers are to strike against the bell, the touch piece is moved away from contact with the hammers, and when one advances it to receive the blows it is necessary that it is fully presented, that it does not prevent opening or closing, and it does not come too near the bell.

Lesson 8

The push-piece action and functions of the repeater-work

- Q.** The push-piece action is important and difficult to execute.
- A.** The most important is the position of the canon, which must be, as we saw in its preparation, such that the level of the hole is horizontal with that of the winding-rack, so that its action is done without resistance. And as the push-piece must act over its whole length without wavering, it should be understood that the larger it is the greater the rubbing surface and the more solid it will be. Before adjusting it, one will take care to broach the hole of the canon perfectly cylindrical, so that it is smooth and without any defect able to retain dirt, which would cause hard friction and wear out the push rod.
- English steel is used, in which the parts are more uniform. The push-piece must be cylindrical and occupy all the length of the canon, except for a small amount where that of gold enters, which is turned on the steel part so that both make one cylinder.¹⁰⁶ One will then notch the steel to two thirds of its thickness, keeping a small edge at the bottom, to hold it in the canon.¹⁰⁷ As for the head which acts on the winding-rack, it will be seen whether after the third quarter the heel leaves sufficient space, if not it is decreased to about half a ligne, preserving the largest edge to retain it and resist the movements which are made with a repeater using a push rod. The gold part is shortened so that, having released twelve hours, only half a ligne remains to be used in the event of the chain lengthening. The two parts of the push-piece are joined by two pins, seeing that the bow is parallel with the flat surface of the push rod. In this state, one adjusts the plate in the canon with a shoulder in which it just enters. One will leave the largest possible space between the bell and the foot of the canon, which carries the plate, so that the vibrations are not stopped by it. This plate will have to be held firmly by a screw and a foot to resist the efforts of the hand on the push rod, whose friction must be light but without any play. When this is done the push rod is hardened and polished, including the gold part. The rubbing part will be only smoothed over its length, which is preferable to polishing. However, the push-piece can only be completely finished when the repeater-work is assembled and functions correctly, because alterations might be needed. For example, if there is not enough time between the last hour and the quarters, it is necessary to cut back the quarter-rack gathering-pallet. In this case, the push rod must be also moved back. If, on the contrary, there is too much time it is necessary to make a new gathering-pallet to raise the quarter-rack sooner; the push rod would then have an unused interval.
- A pin is placed in the top plate, opposite the push rod, to retain it, so that when opening and closing it cannot enter the frame.

Adjustment of the dial

- Q.** Before assembling all the parts, isn't it advisable to adjust and fix the dial?
- A.** Yes undoubtedly. First, it will be seen if it is square underneath, which must be done before assembling it with the case; that is, it is flat and quite uniform with the collar. One will bore the hole for the screw a little below twelve hours, making sure that this screw does not come too near the minute wheel. One also holds it by screws at the dial feet. One will fit a small arm on the collar for the screw, at the height of the inside of the dial; but before boring the hole, one will assemble everything in the case to see whether the dial is exactly in the middle of the bezel. Then one will mark the hole on the arm which must hold the screw, and tap it while inclining it to its larger end, so that the screw holds well horizontally¹⁰⁸. As for the hole in the dial, which one will have bored with a diamond or a well sharpened graver, attention should be paid to see that it is rather large so that it is held only by the head of the screw; otherwise it would break easily. One will then make the edge of the dial flat with both collars, so that they form a single edge, are well joined and no dirt can enter the repeater-work.
- Q.** Is the shape of the dial unimportant and, in connection with repeater-work, shouldn't it be so?
- A.** It should be so, but those who make or fit dials do not take this precaution, from which major disorders of the repeater-work arise which often result in having to distort it to make it function. They push this to the ridiculous extreme of lowering the collar without considering if it is not already too low, according to the height of the repeater-work parts, and which would require a very curved dial.
- Q.** What will the caser do in these situations which require lowering?

106 The push-piece is made in two parts, the visible part being made of gold (or silver) to match the case.

107 The push-piece, to which the bow is attached, has to be free to move. But it must not be possible to pull it out completely, and it must not be allowed to rotate. It is held in the canon by a flat plate against which the flat of the push-piece runs; and a disk is left at the end of the push-piece so that the plate prevents it being pulled out.

108 The hole is tapped at an angle so that the screw head is square with the curve of the dial.

- A. He will adjust the height of each stud under the dial. He will then see if the quarter-rack touches at its ends, to lower it. After that its canon is shortened to the level of the stud; often wavering results from this which obliges him to make another stud. If the quarter-rack is lowered a lot, it will be able to touch the star, and it will be necessary to thin or lower the star. All this damages the repeater-work and solidity of its functions.

When all the parts are free under the dial, they are taken off to round and polish the studs and the screws, and to polish and clean everything. Then the plate is smoothed for the last time, so that it does not need to be changed again and the assembler can reassemble the repeater-work without trouble, with the same functions as the case has returned it.

Continuation of the functions and assembly of the repeater-work

While reassembling, one will again examine the action of each part. The springs of the pallets often work incorrectly, particularly that which leads the two pallets of the large-hammer, known as the double action spring.¹⁰⁹ One will check that, when the hour-pallet returns, the quarter-pallet is held strongly enough not to leave, by a strong push. One will make it retrogress by hand, to see if the spring returns safely and it maintains its height, so that it cannot rise and pass over the pin. One will make the same examination of the spring for the pallet of the small-hammer, which often does not come back after one makes it move the pallet beyond the passage of the quarter-rack.

One will check that the chain links are quite free and the chain is free in the pulleys; if its ring is solid and flexible, and free in the winding-rack; and if the winding-rack is quite free under its key. One will round all the edges, angles etc. of the lower parts of the winding-rack so that its friction is light and it does not scratch the plate.

The arrangement of the repeater spring contributes much to the running of the train and the uniformity and the energy of the blows of hammers. It is necessary that it makes $3\frac{1}{2}$ turns, that the arbor has as a diameter of one third of that of the diameter of the barrel, that the hook is in the middle so that it leads the spring without pressing it against the bottom of the barrel or the lid, and finally that the spring is not too high and constrained in its development. Then the repeater-train is put in and, tightening the spring to the top turn, one will see which turn makes it strike most uniformly and fix the pulley at that turn. But before doing so one will make it strike twelve hours and three quarters to make sure that the chain is the right length. All the steps of the snail must also be tested, because if it has been cut too small so that it strikes one hour too many, it is necessary to turn down the large pulley. If, on the contrary, all the steps strike one hour too few, then the arm is shortened until it drops correctly on the steps which appear to be cut deepest. When the chain and the arm are fixed all the steps of the snail are carefully equalized.

A little should be left after the reduction, so that in the event of the chain lengthening (which always happens after some use) it will still strike the indicated hour.

- Q. It appears that repeaters strike fewer hours, if the precaution which you describe is not taken. However, I have seen some which, after long use, struck one hour too many; how does that happen?

- A. These cases are very rare, and can be produced only by clogging of the chain on the pulleys, caused by dirt which increases the diameter of the pulleys. Or when the hole in the plate which carries the canon of the star-wheel and snail is not well made. There are workmen who are satisfied to tighten it slightly and then it enlarges and allows the arbor to move the snail away until it allows the chain to release one hour more.

After checking these functions of the repeater-work one needs to examine the quarter-snail and the surprise-piece.

- Q. You did not mention equalizing the rays of the star; isn't that important?

- A. Yes definitely, but this is done only when the surprise-piece acts correctly, by the direct relationship which it has with the quarter-snail. This is why first it will be seen if it moves freely in the star without making the all-or-nothing piece move back. If the all-or-nothing piece moves back the button will have to be decreased a little. If, on the contrary, the button is too small, the star will not advance the surprise-piece enough to stop the quarter-rack when one makes it strike sixty minutes. It is then necessary to enlarge the button by making another surprise-piece. It is necessary, moreover, that when the quarter-rack descends to the deepest step of the snail and if, while advancing the surprise-piece, that it makes the jumper pass to other side of the star ray, so that while the quarter-rack is going up, the surprise-piece comes out sufficiently. Also, sometimes the jumper-spring is badly formed, too angular or not sufficiently angular; it is advisable to form it so that it rises softly and drops with force. To equalize the snail one will start by seeing whether the steps are of a suitable height for the pallets to pass freely, and to have enough safety so that they can strike only the quarters indicated. Next one will equalize the divisions by means of a temporary hand placed on the square of the canon

109 Figure 1, 2: *q*. This spring is slit so that there are two springs held by a single foot. One arm of the spring controls the quarter-pallet and the other controls the hour-pallet.

pinion so that the point is at sixty minutes when the surprise comes into action. One then drops the quarter-rack on the highest step of the snail by the pressure of its spring and, while turning the hand, one will hear it fall correctly on each division, if the snail is equal and the dial is well divided. If that is not so it is easy to equalize it, by moving back the steps where the hand passes the point. It is difficult to correct it if, on the contrary, the quarter-rack drops early. If it is only by a quarter of a minute one can, by altering the jumper, make it drop a little later on the sixty minutes. But if there is a greater variation, it cannot be repaired in the same way because of the action of the surprise-piece with the quarter-rack and the hour-snail which is displaced; In these cases it is necessary to remake the quarter-snail, or to add an *over-arm* to the quarter-rack which is wider on the inside and which, consequently, will drop later.

Then the rays of the star are equalized so that they cause the surprise-piece to come out on the sixty minute point. There are two ways to equalize them: one by curving the ends and the other by filing the ray where the button of the surprise-piece acts so that it moves later. The latter method is preferred because it does not disfigure the star. But first it is advisable to carefully inspect it, because if the inequality is from six to six (one side to the other), it would prove that it is not round, and in this case it should be equalized on a lathe.

One will pay great attention to ensure that it is firmly held in its frame, without constraint or play. When all the parts function correctly by themselves, one will make them function together, for every hour and for all the quarters. Initially this is done while pushing gently, to see whether, after having released, it strikes the hour indicated. Then it is tested while pushing very hard, in order to ensure it does not strike too many. One will test the repeater spring, by not pushing up to the point to make it release, and checking that the train runs without striking. Then test to see that the last quarter is not too slow and strikes with difficulty, and that it locks on returning; which would be caused by constraint of the winding-rack, or push-piece, or by too much resistance of the of the quarter-rack, of the hour-pallet, or the repeater spring. All this diligence contributes very much to the merit of the repeater. Those which have trouble striking and returning the last quarter, although they are otherwise well made, are always unpleasant and will be scorned.

Repeaters with dust caps

- Q. You have not yet spoken about repeaters which have dust caps and why they sound worse than those which do not have one?
- A. There are exceptions, but it is true that the majority make unpleasant sounds. However, what is most annoying is that dust caps are only added to the best pieces.
- Q. What is the cause of this dissonance, and how can these pieces be made as harmonious as others?
- A. We saw above that anything that approaches too near the bell stops its vibrations. But here there is another cause, which is almost unknown to watchmakers. It is that dust caps also vibrate, and joined with the vibrations of the bell are very unpleasant. This happens especially when the caps are too tight, the hammers approach too near, and the metal of which they are made is more or less alloyed.

The only way to cure these problems is to move the inside the cap away from the hammers. I have often restored harmony by opening the caps to make more room for the hammers.

But particularly the outside of the cap must be far away from the bell. For this it is necessary, if the pillar plates are not made purposely with a projecting edge, to make a projecting edge on the collar or dial plate; this edge takes the place of that of the plate to enter the case, and forms at the same time the interior size of the bell. In this manner the case is a little larger without being higher, and sounds very well.

A great number of stratagems have been employed to improve the sound of watches with dust caps, but the only one which was successful for me, after having tried all the others, was to thin the bell, or, as I have said, to make space for the hammers. The following fact will prove the truth of this assertion: The maker of a very complicated and valuable watch, having consulted everyone to make it sound acceptably, brought it to me. As I had an excellent English bell, I made some others in various forms, and the worst succeeded best, because it was thin and in conformity with the case and the cap.

Assembly of dumb repeaters

- Q. What are the differences in assembly between dumb repeaters and those with a bell?
- A. The difference consists of placing in the case the masses which receive the blows of the hammers, on whose positions the good harmony which they have depends. Because if the contact is too near the end of the hammers, the blows would be weak and unpleasant; just as when the masses are too low, the blows would be given fleetingly and the tone would be weak and false. It is thus necessary to place the masses so that the blows are given on the lines of the centers of the hammers and at two thirds their length; then one will have full and clear blows;. For this it is necessary that the masses

are placed in the bottom of the case and not at the collar as some do it. That they are large and are well strengthened with solder, the ends are rounded, and the hammers do not stop on them, but they have a small space for circulation of the air which transmits the sounds. Moreover, the springs of the hammers must be stronger with less tension, and arranged so that the force is the same when the hammers are lifted as when they go down.

When all these precautions are taken the parts sound very agreeably.

Assembly of repeaters with double cases, called English repeaters

- Q.** Does the assembly of repeaters which have several cases differ from the previous ones?
- A.** The assembly is done in the first case, which is of a very different form from those which we have discussed. The hinge attaches to the dial plate, and all of the movement enters the case. There is, consequently, less adjustment. When the hinge is made, the plate is fixed to the dial plate by a stem or long screw which crosses them. Then one bores the hole for winding the mainspring in the case, which is marked by using a planting tool.¹¹⁰ When the bell is fixed, one bores the corresponding hole in it with a graver, taking care to avoid the star wheel jumper-spring. Then one shortens the fusee square to be level with the case, so that it can open and shut. Otherwise everything is made as I described previously.
- Q.** But the canon which carries push-piece is fixed differently and some are made of brass?
- A.** Indeed, the English do make them of brass, and held to the case by three screws. But in addition to the bad appearance which this metal has with gold, it carries the push rod too low for repeater-work of ordinary height. This is why it is preferable to solder a canon of the same metal as that of the case, than to raise the hinge, so that the push-piece acts fully on winding-rack on the line of centers. Besides, they are more solid and the bell is held higher, which is a very great advantage for it to be loud.
- Q.** Why do these kinds of watch sound much better than others?
- A.** It is 1, because they are always of a higher form and consequently the bell has a higher circle which increases the force and duration of its vibrations; 2, it is less obstructed by the shape of the case; 3, the cases are very thin and have much space, especially the first; and finally, because the mainspring is more powerful, since the resistance of the train is not increased by its height. One even notices that it has more freedom than those of thin watches.

¹¹⁰ Unlike continental watches, which wind through the dial, English watches wind through the back of the case.

Part 3 - Finishing

Lesson 9

Finishing the repeater-work

Question. What is meant by finishing repeater-work?

Answer. It is the harmonising of all the parts, a task that is limitless and on which the fate and the price of the repeater entirely depends. It should only be done by masters well versed in the art and their payment is as unlimited. Since one often sees the loss of as many dollars as the number of cents one has tried to save on this interesting and final work, and parts generally badly made, having been well finished, one has an obvious preference for those of superior hand work.

Q. But how, when all the parts are well made and carefully examined, can they fail to function correctly and provide work for the finisher?

A. One needs an infinite amount of care which is often neglected in every part, that is to say by ignorance, or because one allots them to finishers. The actions will function well for a few days and then work no longer; in other cases they will miss in certain positions, or in extreme seasons, etc. But what is more common and more annoying is the great number of people who undertake finishing repeaters without having acquired sufficient knowledge, who pervert them and return them in worse condition than when they were given to them, and it is only by employing much more time and by doing much more work that they finally function.

Q. What are the steps which it is necessary to follow in the execution of this work?

A. I assume that one receives the watch from the case, and so the first thing to do will be to see whether the case closes well and whether the watch functions well. Check the bezel, if it presses too hard, and the hinge. Check the fastening or dial spring, that it enters and the head does not touch the bell, being pushed in by the bezel. If the silencing device works, first by touching the button gently to feel the distinct blows, and then pressing hard to make sure that it has a stop which prevents it from going down so far that it entirely stops the blows.

Make the watch strike twelve hours and three quarters to make sure that the push-piece penetrates far enough and no further, and that the last quarter is not constrained. One will turn over the watch and make it strike, to see whether there is any variation caused by friction or the movement of parts. One will then make it strike suspended by the push-piece, which is the hardest test. If in this state it strikes the three quarters boldly, it will never miss in the ordinary positions.

One will listen attentively to see if the vibrations of the bell are obstructed by the approach of parts. One will then open the bezel to see whether the dial joins well with the collar, and the collar to the case, so that dirt cannot get into the repeater-work. It will be seen whether the dial spring acts correctly, if the hinge is well adjusted and is not checked, if it stops when opened square, and that the edge of the dial does not check it at the same time, which would cause the dial to break.

One will use the hand to examine the position of the twelve rays of the star wheel, to see if they are aligned to sixty minutes, then the divisions of the quarter-snail to the four quarters of the dial, and the steps in order to ensure the quarters strike truly with the indications.

It will be seen whether the touch piece acts without obstructing the hammers in its normal position, that it does not approach the gongs and obstruct their vibrations. If, when it is presented to the hammers while opening and closing the movement, it does not catch on one or the other of the hammers, and does not prevent closing; and finally, that it is firmly fixed so that it does move while functioning.

One will make the counter-springs act by the counter-spring screws, which must be very solid so that they cannot be loosened by the impulse of the blows of hammers. One will take off the dial and examine the screw which holds it, which must be hardened and tempered and not sit above the dial.

One will then check the quarter-snail to see that it is well riveted onto its canon, that it is at a good height for the quarter-rack and the star wheel, that it does not touch the canon of the minute wheel or the spring of the quarter-rack.

The surprise-piece is examined to see that it is held so that it is free and without play, that the button passes the highest steps of the hour-snail with a sufficient space not to touch them, which can happen in some situations. If the pin on the quarter-snail, which controls the movement of the surprise-piece, is not too long and touches the rays of star; that the collet which retains it does not touch the snail at the one hour step; that the winding-rack, while moving down, does not touch the collet or the button of the surprise-piece, which would advance the hands each time one pushes on it. Finally, one will carefully examine the action of the surprise-piece and if, when entering the star, it moves aside the all-or-nothing piece because its button is too large, which would stop the movement; if it is too small it will not hold the surprise-piece in position to receive the arm of the quarter-rack, which will push it in while dropping onto the three quarter step. When the quarter-rack is descended one moves the

surprise-piece out against the arm to see if the jumper-spring passes the end of the ray, in order to advance the surprise-piece when the quarter-rack returns to its rest position.

One will adjust the motion work. One will see whether the minute wheel is well placed and not too close to the winding square or the dial screw and if, while leading it to the twelve hours step, the winding-rack is not stopped by the canon or the arbor; if the pinion touches the dial, if it is quite free without play, in order that there is always space between it and the snail and the hour wheel. One will check the height of the hour wheel under the dial and will not forget to count their teeth to make sure that they have the correct number. Neglecting to take these precautions often causes great problems for finishers. With all the other wheels, except the escape wheel, a tooth more or less does not have a significant effect, but with the motion work it is not possible.¹¹¹

See if the hour-snail or the star touches the fusee arbor. In this case one should not move them, nor file the one hour step, as some workmen do, but make a throat in the fusee arbor. However, in the case when the star is larger than the snail, one can decrease it without fear. The same attention will be paid to the barette of the contrate wheel, and the high foot which carries the all-or-nothing piece, against which the highest step of the snail often touches. Before anything is dismantled, one will see whether there are any parts which are too high and obstructed by the dial; or if any are too low and so can slip from their places when the watch is carried in different positions. One will see if the gathering-pallet which brings back the quarter-rack is restricted, if it is well retained by a pin and if, while turning for striking the twelve hours, its back does not touch the pin; a space is needed to prevent the chain being stretched.

This quarter-rack gathering-pallet is the first part which is removed. Then the quarter-rack drop-spring is removed after seeing that it drops the quarter-rack properly when the all-or-nothing piece is drawn aside¹¹², and it does not press too hard or rises while acting so that it leave its place, especially if the pin it acts on is too short or tilted. Often the pin is not carefully examined and this simple fault is neglected, as for the other small pins, and repeaters are sometimes returned from 200 miles away. These pins should be put in from the top and riveted underneath.

The quarter-rack is taken off, examining whether it is well adjusted on its arbor, free and without play. One will test the arbors, the keys and the screws, seeing that they are well tightened, and if the caser has not loosened them to give play. Without this precaution one would be astonished, when re-assembling, to find the actions are not done; because, as I mentioned above, one returns all to the finisher, who cannot trust anything and must ensure everything is good himself before gilded re-assembly, since he is responsible for all the problems.

While removing the collar, one will see if it obstructs any parts; if the keys hold it well, do not turn too much, have a stop on the plate, and their places are numbered.

One will pay the greatest attention to the adjustment of the star with its snail, that the hours are well divided, and it is free without play. One will see if the winding-rack goes down to 12th step of the snail without obstructing the star and if the canon supports it well on the plate, to take the effort of pushing, without which the arbor would be bent or would break. It is necessary that in the at-rest state it does not touch the plate. This is observed from underneath when everything has been disassembled. One will check all the steps of the hour-snail by stopping the train, and while starting to push on an hour; the drop of the pallet will be observed; it is necessary that after it drops it goes up, by half of its way, with all the steps equally, to prevent the chain lengthening.

One will carefully examine the jumper; of all the parts it is the one which requires to be adjusted most perfectly on its arbor, to hold the star without touching the snail and without passing over star as is often seen. It is important to regulate its action so that it is not too hard while rising up to the tops of the rays. This can stop the movement, especially when the mainspring does not dominate much over the balance, and it most often causes a small delay during this moment.

One will observe the action of the two small pallets, that the springs are not too strong and they return well, that there is a stop to prevent them moving beyond what the quarter-rack needs. In particular, the spring of the large-hammer, which has a double purpose; seeing that when the hour-pallet is moved away by the spring, the quarter-pallet is sufficiently retained to be always brought back.

When one has ensured all these actions, the small pulley is removed, after having seen that the chain

111 A tooth more or less in the motion work would cause the hour hand to rotate in more or less than 12 hours and get out of synchronisation with the minute hand. It seems this did happen occasionally, and later Crespe gives an example of the consequences of it.

In contrast, assume a balance and balance spring are adjusted correctly for a 14400 train and one tooth is removed from or added to a train wheel. Then the watch will run about 1 minute per day fast or slow. In the case of a verge watch this is within expected performance and, anyway, can easily be fixed by adjusting the regulator or the balance spring.

112 The quarter-rack cannot drop while the gathering-pallet is in place.

runs freely and the pulley is not obstructed by the plate; in that case the plate is recessed to free it. One will observe the running of the repeater-train after having tightened the repeater spring, which must make three and a half turns. One will test the key or eccentric which must be placed so that the wheel and pinion of the delay do not approach so near as to break the pivots; but it must be turned very slowly. Also, one will observe the speed and if it is possible to count the blows. It would be advisable to arrange it so that only the watchmaker could adjust it by forming it as a screw head.

It is necessary to check the hour-pallet to see it is quite free, it does not touch the wheel, that it acts fully in the ratchet, and especially that its hole is not too large, because this produces unequal and defective blows without the cause being suspected. It should be seen that it is held far enough away not to engage before the quarter-rack is released. Check that there is enough space to prevent it interfering with the all-or-nothing piece; and if it moves enough to raise the hammer, which one knows by how it escapes, while not having a small drop. If it rises too much and does not let the hammer return to the edge of the plate it should be shortened. One will put the train wheels in the movement one by one to see whether they are touched while striking. First the fusee is put in with its chain, and the beak presented to the hammer so that it passes below and has sufficient space to prevent play of either the wheels or the hammers by the continual action of the springs. It will be seen whether a screw or foot extends above the plate and can touch a wheel, if the heel of the winding-rack, and sometimes the push rod, obstruct the wheel of the fusee or the barrel when going down to 12 hours, if the winding-rack moves freely under its key, and if the heel is not constrained by the plate. It is necessary that the entry is a little more than required by the 12 step of the snail to prevent stretching the chain. It will be seen whether the potence obstructs the first wheels of the repeater-train, and if these wheels come too near the chain, the small-hammer or the potence; and if the large-hammer comes too near the counter-potence.

When one has ensured all the clearances, all the parts are assembled, without forgetting even a single pin. One will again check all the actions, and stretch the chain. If all is well, it is completely disassembled, keeping together the parts with their screws, because although they appear the same they can cause great changes. If, for example, a spring has been adjusted with an out of round screw, by changing it for a round screw the spring will rise or drop and act incorrectly, and consequently the piece will not work properly. One sees from this how significant it is not to neglect anything, even those that appear unimportant to us. I saw a watchmaker spend eight days searching for the reason for a stop, which was caused by a swapped screw which touched a wheel that one could not see. I mentioned above that the plate must be dressed and smoothed for the last time by the caser or the finisher, before the last tests during reassembly, because of the changes to screws which result. Turning more, they hold the parts that they carry differently, which causes them to act incorrectly, and they will touch wheels on the inside, etc.

Before removing the arbors and pins of the hammers to polish them, one will make a guide mark underneath the hammers to indicate their positions; for this it is recommended that the underneath of the hammers is not touched, as some polishers do. Without this precaution one would be astonished to see the hammers leaning because the arbors, not being quite round and put in only a quarter of turn more, they necessarily change the positions of the hammers. It is important to be sure, before removing them, that they are well tightened, as they will have to be when re-assembling them. If they are not they can loosen during striking, which causes the greatest disorder, and which happens especially when the threads are very small and fine. When removing the hour ratchet, it is necessary to make a guide mark on the arbor which carries it to be sure to return it to the same place, because of the relationship which it has with the square on which the pulley is fixed. Those who neglect this precaution are given great trouble and are obliged, after much research, to disassemble all the parts to reposition the ratchet.

If such tests are unpleasant for those who know from the first the causes of these problems and how to cure them, they are described for those who do not understand the functions of repeater-work. Seeing it strike several hours more or less than the indications, and the quarters immediately after the hours or too long a time afterwards, and uncertain of the causes which produced these effects, they employ methods which tend to ruin the repeater-work.

These are the principal tests which the finishing of repeater-work requires. There remain several others that are not described and which depend on the prudence of the finisher.

Lesson 10

Friction

Q. You have not mentioned friction, about which workmen complain and which they consider the main cause hindering the functions of all machines?

A. Nothing is so common as the action of friction. It is met everywhere and one can say, in general, that it is the principal cause of the alterations and deterioration which we see in all machines, especially in those of the watch industry, by their continual motion and the impulse given by the motive power. Continual friction imperceptibly works on surfaces and shapes, and make them lose the qualities on which they depend. The hardest and most solid matter does not have a long service without showing marks of wear. The movement of one surface on another is all the more hindered, so that both will have more inequality, which is varied ad infinitum, according to nature of the bodies.

The use of friction to brake the wheels of cars going down descents provides us a familiar example of the effect of friction: this is first type.

In the same way, when each ordinary wheel turns on its axis, it is displayed on the various parts of the space which it traverses; its friction is then of the least type. Friction is also increased by their speed. Thus if the first wheel of a train has a friction which is opposed to the action of the spring, the spring's force is decreased by it, because of resistance; this friction is then of the first type.

If the last pinion of the repeater-train, which makes four thousand turns for one of the first, has the lightest friction, it does not continue to accelerate; but if it turns gently, this light friction does not stop the acceleration. Which proves that speed increases friction.

It is the same for the parts of a repeater; friction stops or slows their action in proportion to how far away from the motive power they are. This is why it is necessary, in all the cases where one fears a lack of force to activate the machine, to decrease the total of the frictions.

Gilded reassembly¹¹³

Q. Does gilded reassembly require particular knowledge and labour?

A. This part, which is the last, is not difficult to carry out when one takes the same care as in finishing, explained in the preceding lesson. It is absolutely necessary to pay great attention to do everything in order, with delicacy, and especially to have the most rigorous cleanliness.

Q. Are there rules to observe in the method of gilded reassembly?

A. Definitely, and it is easy to understand that if, for example, all the inside were assembled, as the workmen without practice do it, the parts on the outside can, because of some changes or other effects of gilding, obstruct wheels without it being noticed. And besides, whatever care one takes to clean the holes, there always remains a little that the screws cause to fall into the movement, where they cause friction and consequently inevitable stoppages.

Q. What are the steps which should be followed to ensure proper reassembly of the repeater-work after gilding?

A. One must first clean all the holes and broach them smooth to remove the gold, the black formed by the fire, wax or other corrosive matter which can be introduced there. Also, one will have to pass taps through the screw holes, without which the screws would rust before long.

These taps will have to be oiled and be quite in conformity with the threads of the holes for the quality and size of the screws. After which one will use peg-wood points to remove foreign bodies. One will initially put in all the key screws, and one will check the collar to see whether gold has entered the snap, if it has been disturbed by engraving or gilding, and if it fits the plate well.

One will set up the arbors and pins of the hammers, observing that they are well tightened and in their correct places. One will fit the quarter-pallets to see whether they are obstructed by the marks of the pincers used to tightened the stems. One will put the hammers in the frame by themselves, after having examined the holes and removed the gold which can have entered there. One will see whether they are upright and quite free, after which one will put in the springs which should not rub on the plate nor rise too high. One will put on the hour-pallet to see that it does not touch the wheel, that it raises the hammer with softness and releases it without trouble. Care will be taken to oil the arbor a little, the shoulder on which it sits, and the tooth which acts on the ratchet. All the ratchet teeth must be examined to see that they are rounded and there is no bur which would cut the pallet.

One will put in the quarter-pallet springs to see whether they function correctly, after which they are removed to avoid the danger of breaking them during assembly because of their delicacy.

The canon and the high foot on which it sits, which carry the all-or-nothing piece, are put in. It is seen whether the all-or-nothing piece is square and acts correctly, with its key screw and the star, and that it is free. The same with the jumper-spring, if it enters fully into the star without touching the snail.

113 See Berthoud and Auch *How to make a verge watch* for a description of gilded reassembly of the movement.

One will carefully put in the arbor of the quarter-rack so that it does not incline, because the least slope changes the action of the quarters. It is also necessary that it is quite tight because of the action of its spring whose force always tends to loosen it. It will be seen if the quarter-rack is quite free and true, if it passes the star without touching; if, while returning, it draws aside the all-or-nothing piece softly, that the lock is made with safety, and that these two parts are on the same level. One will put in the arbor of the pulley and the pulley, seeing that it is free and does not rub on the plate. Then one will put in the winding-rack with its key, and one will ensure that it moves easily without play, and that it is held firmly.

One will put in the arbor of the minute wheel to see that the wheel is true and free; all the arbors will have to be tightened with smooth pincers which do not bruise them.

One will only assemble the large parts, leaving all the others to be tested on the inside with the wheels which they can obstruct.

One will put in the counter-springs, the dial spring, the hinge and the collar, and make them function in the case, because there are always some changes which need to be made before the frame of the movement is assembled.

Before assembling the movement, one will test the hook of the repeater spring, by putting only the hour ratchet in the frame, to see that it enters the barrel, hooks onto the spring, and it acts without constraint and without friction. Next the click-and-ratchet work of the repeater-train is checked; neglecting this causes serious problems. One will put oil in the closed hole of the eccentric key of the delay and assemble the repeater-train.

One will choose the second turn of the spring to fix the pulley, after having put oil in the hole in the plate.

One will see initially, by pushing the winding-rack, if the twelve hours strike easily followed by the quarters. If the drop of the hammers is changed (for example, if it is too fast) it would prove that the quarter-rack is tilted towards the small-hammer; however, if the quarter-rack is right and the large-hammer rises sufficiently, one could shorten the pallet of the small-hammer a little. If, on the contrary, there were too much distance between the drops, it would be necessary to alter in the same way the pallet of the large-hammer. But in these cases it is necessary to alter it only with prudence and knowledge of the cause; through ignorance some workmen cause the large-hammer to escape first, and remove the safety on the quarter-snail.

One will examine the hour-snail again while making it strike on every step, to see if the chain has varied; one will test the quarter-snail and the surprise-piece in the same way. When the actions are correct, one will pin the gathering-pallet which brings back the quarter-rack.

Before assembling the parts which are in the case, it is necessary to clean it well. Matter can remain in the interior angles which, if suddenly detached, would enter the movement and stop it. It is especially necessary to put oil in the hole of the screw for the bell, and that it is left there for at least an hour to spread and detach cement or other things which can be there. Those who neglect to do this ruin cases and break valuable enamels: it is the same when the screw is too long. The bell is put back in the same place, which must be marked by a point opposite the push rod.

It often happens, when the case is thin and is gilded after assembly, that it is curved in the middle and the bell touches the bottom and cannot sound; which causes trouble for finishers. In this case it is necessary, if the bell is thick and the tone high, to thin it where it touches and to make it conform to the case. One should not fear this operation which is always advantageous by giving freedom to the vibrations with a lower tone and the sounds will be more harmonious. If the bell is already thin, and consequently has a low tone, one will raise it by a piece of paper or, if that is not enough, a card cut square. But if it is badly positioned, it is then necessary to fit a brass washer by which, being thinner on the side which rises, one can easily correct it. It is very important that the screw is large and quite tight.

When all the parts are thus assembled and one is sure of their actions, the rubbing parts are oiled.

Oiling repeaters

Q. As oil contributes to making parts dirty, wouldn't it be better not to use it?

A. It is absolutely necessary to put oil on all the rubbing parts of watches. However, if one considers the changes which occur through cold and heat, the nature of its quality, how brass affects it, and that that it is left there for several years, one should be all the more surprised that a watch can go even one night, exposed to cold, when one considers the effect that it has on oil; because cold stops the oily property and give it a firmness which obstructs the pivots, so that the repeater-train, for example, is constrained to the point of not having enough freedom to raise the hammers. From which it results that a watch must similarly vary since it is obvious that these changes have the same effects on what the various motive powers produce.

The conclusion which one must naturally draw from these disadvantages is that oil must be looked

Essay on Repeater Watches

upon as one of the greatest causes of the continual variations which occur in watches, and which it seems one can never cure.

- Q.** Which are the parts of a repeater where it is essential to put oil?
- A.** All parts acting with the large pallet, as I mentioned above, on the hammer holes, the ends of the springs which act against the pins, on the stud of the quarter-rack and at the end of its spring, on the pallets and on the gathering-pallet, on the end of the locking arm, in the hole of the fixed pulley, under the key of the winding-rack, on the push-piece, the part which rubs on the plate and that which acts on the heel of the winding-rack.
- Q.** Which are the places where oil is harmful?
- A.** The surprise-piece, where it would obstruct the action; on the rays of the star wheel; on the jumper-spring, because it would be communicated to the surprise-piece; and this is why the star is made of brass. One should not put oil on the pulleys, as some makers do, because it attracts dirt which increases the diameter of the pulleys and makes too many hours strike; moreover, it causes the chain to become stiff. A lot on the repeater-train is harmful and frequently causes it to stop, especially in the cold seasons. The motionless state of these wheels facilitates the coagulation of oil, from which it results that those which have too much oil have difficulty in starting to move, or go very slowly; so that on being transported to a hotter place their speed will be increased in proportion to the thinning of the oil. If one were satisfied with only passing an oiled peg wood in the holes, one would avoid these problems.
- Q.** It being essential to put oil on the train, couldn't one find an oil which does not change in these ways?
- A.** It should not be doubted that a matter of this importance has not excited the rivalry of several watchmakers who, after much research and many tests, even fanciful ones, recognized that olive oil, the first oil which was used, is the best. But it is necessary to extract the most delicate parts from it, which preserve their fluidity best and which are in the center of the vessel. It has been noticed that oil of Nice, whose colour is equal to that of olive, is preferable.

Compendium of the faults which most frequently stop the action of repeater-work

When the repeater spring is badly made, soft or too weak, with a bad curve which does not develop in a good spiral; when it is constrained between the barrel and the plate¹¹⁴; when the hook on the arbor is put too high or too low, or the arbor is too small, having less than a third of the internal diameter of the barrel; when it is obstructed around the hole in the barrel, sometimes by the plug of potence; etc. The least of these, to which one often pays very little attention, will considerably decrease the motive power. It is necessary to give great freedom to the arbor around which the spring wraps, so that it can develop most easily.

When the hammers are not quite free and upright in the frame, in height as well as in the holes for the pivots, especially the top one; then while striking, the springs always act too far from the center, move them sideways, harden the action, and make them touch wheels or the plate, etc; which happens particularly with the quarter-pallets, and misleads finishers who do not allow for it. When one is satisfied by putting them in free without the springs and the pallets, it happens, especially when the holes are not upright, that the pins which go through the plate rub on the openings, especially after gilding when one forgets to remove the gold which is introduced there. Moreover, one sees some watches stopping, after having functioned for some time, by the arbors which carry the hammers, which were not quite tight and they have loosened during striking. In this case it is necessary to disassemble the pieces to make them solid and not to be satisfied, as I have seen some do, by tightening them while they are in the frame, which cannot last a long time.

The hour-pallet also causes frequent stops when it is not perfectly free, on its arbor as well as in the plate which it crosses between the wheels, which everyone should know. But it is the case which one neglects or which one cannot provide for which causes great problems. For example, when the hole in this pallet is too large, it will mesh more or less with the teeth of the ratchet and will strike unequal blows. Not only does it lose its freedom when being moved close to the parts following the impulse of the springs, but it can happen that when the quarter-rack has suddenly moved to its rest position, that it moves sideways and props between the head of the quarter-pallet and the arm of the quarter-rack, and cannot go further. In this case the only remedy is to make another.

When the pallet, which is the tooth that acts on those of the ratchet, is not rounded at its end and has, on the contrary, a dish, it clings to the end of the teeth of the ratchet and is strongly held to them, especially when the teeth of the ratchet also have the same form; this is easy to cure by rounding them.

Before leaving the action of the hour-pallet, let us observe what frequently happens when, after having escaped, the hammer instead of returning to its place after each blow, drops onto the following tooth. It happens that when moving the hammer to strike against the bell, all the blows are retained by the teeth of the ratchet, and the last being retained more, it will come much too close to the bell and stop its vibrations. This also happens with the quarter-pallets. It is necessary, in this case, to shorten and close the pallets; or if contradiction is feared, to make the hammer return by its counter-spring, and approach the bell if it can.¹¹⁵

A similar case in a repeater brought to me, but produced by another cause, is that after having struck twelve hours and two quarters well, the bell became entirely silent on the third quarter. Having examined all the projecting parts inside the frame. I saw that the hour-pallet could touch there; I put on some rouge and proved it. When the watch struck the hours and two quarters, the pallet was inside, but it touched with the third, because the quarter-rack made it move to the edge of the plate. Having seen that the bell was too close on this side, I put it in the middle and it no longer touched.

I report this anecdote here because there are many hour-pallets which rise too far at the edge of the plate, and stop against the collar, the case or the bell. It is important to check this during finishing.

Stoppages caused by the silencer

When the silencer is not well fixed to the plate, its ends can rise and pass under the quarter-pallets, and then the quarter-rack, having dropped, is locked and stops. The canon pinion which carries the quarter-snail then rotates to meet it, and so the movement as well as the repeater-work stops. In this case it is necessary to tighten the silencing device by its screw, but not too much, keeping freedom for it to move, and cause the ends to drop; or to thin them enough so that they cannot touch the pallets. When one fits this part on the plate, and its action is examined; it is not always thought that its projecting arm can be obstructed by the collar, which tends to make its ends rise.

When the silencer moves too far to the hammers, they can remain propped up on the ends, and be tightly held; which consequently stops the action. One thus needs a stop, for which the repeater maker

114 Spring making is described in Berthoud and Auch *How to make a verge watch*. The barrel is fixed to the plate and the plate itself often serves for the lid.

115 *si on craint de démenter, faire rentrer le marteau par le contre-ressort, et approcher le timbre s'il se peut*. I presume that by *contradiction* Crespe means the order of striking is altered.

uses by the spring of the small-hammer or the key of the collar, and the finisher by a simple pin in the plate. Moreover, this stop is important in order to leave enough space for the hammers to strike against the silencing device.

Stoppages caused by the pulleys

When the chain pulley is not raised, sits too low on the plate and is held against it by the pin through the square above the quarter-rack gathering-pallet, it causes friction able to stop the last quarter, especially when the quarters are done unequally.

The same thing happens when the pin which holds the chain to the pulley extends underneath and rubs on the plate.

When this same pin extends above, the quarter-rack, which often passes over the pulley with very little separation, touches it causing the action to stop. The number of watches that I have seen like this is infinite, because many workmen seek the solution elsewhere without suspecting this cause which is not obvious.

The same pulley, almost always very thin, may have been curved when putting it in or removing it without due care. The chain, which must run on it very freely, will be hindered and miscount the hours or stop the action. Also, in the same way after long service, dirt which the chain carries settles in the pulleys, increasing their diameter and producing an error.

If the stud of the fixed pulley is tilted there will be friction with the plate, which stops the last quarter. But especially if it is elevated with regard to the winding-rack, the end of which carries the ring for the chain. It can happen that instead of the ring entering, the two edges will meet and the last quarter will not be able to strike, In this case it is necessary to put the stud of the pulley quite up right, or to decrease it by sloping the lower edge, which will facilitate the passage of the winding-rack or the ring, as I do with all the pieces that I finish when casing them.

Stoppages caused by the chain

As people are not careful enough in the choice of good chains to use with repeater-work, it often happens that they break, because of their defects or by touching parts during the impulse of pushing. When such a watch comes to the hands of a skilful workman the fault is not difficult to repair.

But what happens when a similar accident accompanied by the loss of some links comes into the hands of a country watchmaker, the majority of whom have no understanding of repeater-work? He will rejoin the chain, as he would rejoin a fusee chain, clean the parts and he will believe it well repaired, when all of a sudden he is astonished to find that it strikes too many hours and not enough quarters. He is tormented for a long time, but if he is intelligent he will lengthen the chain by a link or two. This results in a new embarrassment for him; it strikes not enough. I have seen several cases of them having succeeded in giving it the correct length, joining not quite similar links, but there will always be differences which will cause errors. It is thus necessary, having come as close as possible to the right length of chain, to remake the ring which holds it to the winding-rack so that it is longer or shorter.

If it happens that there is chain between it and the winding-rack, which happens rather often, and the piece strikes one hour too many, it is proof that the chain is too short. Then one will decrease the internal diameter of the fixed pulley little by little, until it releases precisely the number of hours indicated by the snail. If on the contrary the chain were too long and it strikes one hour too few, one will decrease the arm of the winding-rack which falls on the snail little by little and with the same precision. But before doing this, it should be made certain that the push rod, as well as the winding-rack, can be inserted fully into the piece.

It is very important to make the chain flexible and to ensure the ring moves freely; otherwise a great many pieces have trouble striking the last quarter, or do not strike it at all.

Stoppages caused by the winding-rack

The action of this part is so simple that it rarely causes stoppages. However, more than once I have seen winding-racks, when not well retained under their keys, rise and come to a stop against the collar or the hinge. By the same cause, when the hour-snail is thin or has play the arm of the winding-rack, pushed with force, can pass over the snail, engage with star and remain there, causing everything to stop. Especially if the end of the arm is finished in a slope, it will force up the snail to let it pass under and will so stop all actions.

Stoppages caused by the quarter-rack

This part can cause as many different stoppages as it has different actions. It is the part which requires the most care in construction and which decides the fate of the repeater-work, because it causes the most frequent disturbances of all, as I will show.

When it is not quite free on its stud, and there is some dirt there, the spring which drops it tends to loosen it. This is more so because this stud normally has very little solidity, the plate at this place being extremely thin, and this requires the greatest attention of finishers. It must be well understood that if

this part has shake, it will cling onto its neighbours, and will not be able to return.

If when tightening the stud which carries the quarter-rack, one makes it incline towards the large-hammer more than the other, the drops will be too far apart. That is, the small-hammer will escape a long time before the large-hammer and perhaps the large-hammer will not escape at all. The pallet will remain hung on the end of a tooth, and the hammer being moved in too far will sometimes stop the train of the movement. It is the same for the small-hammer if the quarter-rack is tilted on its side. The drops will then be precipitous, by making make more way with the small-hammer which, not being able to escape, will remain on a tooth or will stop the train.

If it is tilted towards its snail, the arm which drops on the snail, if it is simple, will pass under it and will miscount the quarters; just as it will pass over if it is tilted to the other side.

All this proves how much it matters that the quarter-rack is set horizontally, well fixed and free on its stud.

Let us pass now to its other functions.

A great number of repeaters have trouble striking the third quarter, and several stop at this point. This is an event which will not astonish us if we consider how many actions take place at the same time and how much resistance the motive power must overcome at the time when it is at its weakest. First, the spring of the quarter-rack is often too strong. Those of the two hammers, the spring of the hour-pallet, and those of the all-or-nothing piece, each one of them can cause a particular stop of the action of this part if they are not proportioned one with the other. The first is when the spring of the quarter-rack is too strong or presses on the quarter-rack and will stop it before it achieves its effect. I made a great number function by decreasing this force or by removing the pressure (because it is not necessary that this spring touches the quarter-rack as some watchmakers believe), or by smoothing the end which acts against the pin, which is often left with marks and burs able to stop the action; this happens especially when the pin is placed too high. If the arm which leads the hour-pallet is not arranged so as to act on it fully, and its spring is at the same time hard or obstructs the quarter-rack, it will not fail to stop. When that of the all-or-nothing piece is too strong, like that of the jumper-spring which pushes it back, and when the arms which act one against the other are not smoothed, because there are burs or furrows across them, it is clear that the motive power will not be able to overcome them and the quarter-rack will remain in the way.

This part is often obstructed or stopped by the pulley over which it passes, which always tends to rise when it is not held down.

I have seen watchmakers seek everywhere for a failure of the third quarter which was caused by the canon of the part which returns it, and against which the quarter-rack stops. But the most difficult to recognise is one of most frequent; it is when the pin which leads the quarter-rack is badly placed, the arm which moves it is badly formed, and entirely loses its force before the last quarter. It is the mystery of repeater-work, and workman without theory are puzzled, because by the direction of this arm and the situation of the pin, one can make the last quarter strike as easily as the first. It would be difficult to enumerate all those which I have made function this way, and the majority were distorted so that they could not work.

Before leaving this part we should stop for a moment on a problem for the majority of watchmakers, which is to equalize the fall of the two hammers for each quarter, and the effects which result from it. For example, when they are too precipitous and they escape almost together, their first idea is to shorten the pallet of the small-hammer which must escape first; I have seen some making the large one escape by ignorance. What happens by shortening the pallets? The small-hammer already rising very little, will not be heard any more, and moreover the pallet will escape at the hour without quarters, as with the other steps of the snail.

It will be the same if one shortens the pallet of the large-hammer, when its fall is delayed too much after that of the small-hammer. One must, when one is forced to do this, make sure that there is enough safety on the quarter-snail, so that this reduction can only allow them to pass on their right step.

But, one will ask, how can the drops of the quarters be equalized when they are unequal? This occurs because the teeth of the quarter-rack are unequal, unequal in height as well as in spacing. It is necessary, in this case, to equalize them as much as possible. If they become too short, then the pallet needs to be stretched or a longer one made. But the pallets can only be shortened if they would raise the hammer too much, and would escape onto the following tooth, which would retain the hammers and causes a very unpleasant dissonance. If the hammers escape close together and the pallets cannot be shortened, it is necessary to lengthen the arm of the quarter-rack which operates the small-hammer; this is done by striking with a hammer a little sharply on the opposite side, on the flat, inclining, as long as possible, against the edge. The effect is very sensitive, especially when one strikes close to the center of the quarter-rack.

If, on the contrary, the drops are too large and the quarters are struck like hours, one will do the same operation, but on the other side.

The need to inform the majority of repeater makers of the actions of the quarter-rack and how they

are done, makes me hope that I will not be reproached for having spent so much time on them. If I have rendered them comprehensible, in the future I will have the satisfaction of seeing repeaters striking the hours and quarters with more precision than do the majority of those which exist now.

Stoppages caused by the spring of the two large-hammer pallets, called the double action

The inventor of this spring was undoubtedly of the same opinion as those who say that it is necessary to reduce the number of parts to make the action of them surer. If it were not manifestly clear that this spring causes more stoppages than any other part, one could plead other evidence to destroy this prejudice; each part of the repeater-work having its particular function, one can only remove some by charging others with a double action, and one action causes the other to miss, as will be shown.

While the hour-pallet holds the spring drawn aside, the quarter-pallet remains free. When the quarter-rack has dropped, and the hour-pallet remains behind, as often happens, that of the quarters having retrogressed, without being brought back, will butt on the end of the teeth of the quarter-rack, and cause a stoppage.

How often does one see the quarter-pallet leaving its place at the time of the impulse given by the quarter-rack, which it can because there is not a strong enough stop between the spring and the pallet to prevent it from retrogressing. In this case, it is necessary to examine whether, when the hour-pallet is drawn aside as far as it can, the spring can leave the quarter-pallet, even a little, and that the hour-pallet moves the spring too much, with each tooth of the ratchet. It will be enough to shorten the end of the spring, so that it deviates less. If that is not possible, it will be necessary to remake the pallet with a longer arm, or make a spring whose stop is moved back less. Some workmen put a pin in the plate to stop the pallet from moving beyond that which it must retrogress for the passage of the teeth. When repairing, I often successfully put one in with the same spring.

There is not a repeater maker who has not been embarrassed trying to make the quarter-pallet return; when the head is small, the support of the spring being not sufficient to push back it with force; when it is not notched deep enough and it presents, while retrogressing, an angle on which the spring cannot act. If it is moved back too much, the spring stops on the arbor of the hammer, and will have little effect. It would be enough, to condemn it, to show what happens every day, that by tightening or loosening the screw only a twelfth of turn, its action is stopped.

The most important defect of this spring is for it to pass over the pin of the hammer, against which the pallet acts at the point, which enters the silencing device and then this spring has only the thickness of a card of support for the action of the pallet on the hammer. So by the spring rising a little, the pallet is put out of catch, escaping the hammer. This is one of the most frequent cases, and neither of the preceding happen when each pallet has its own spring. When it happens that they do not act properly, he who cannot make them is not workmen.

It sometimes happens that the spring for the hour-pallet cannot bring it back when it has retrogressed more than necessary for the passage of the ratchet teeth, or when the arm deviates too much. In this case it is necessary to round it, or to move it back. With the first, it will be enough to put a pin in the plate, which crosses the rear of the opening, and which will stop the pallet. But it will also be necessary to move back the arm of the quarter-rack which moves it back, paying attention to leave an unrestricted passage for the teeth of the ratchet.

Stoppages of the pallet of the small-hammer, caused by the counter-spring

When one makes the small-hammer return away from the bell, the counter-spring approaches the pallet, obstructs it, and the point butts on the end of the teeth of the quarter-rack and stop it.

The same effect happens when the counter-spring is not well held down; the return screw can be pressed by the collar and make the end rise which then presses on the pallet and will stop it.

The silencing device, as I have shown, produces the same effect on this pallet; I repeat this so that one is not embarrassed at times of need.

Stoppage caused by the all-or-nothing piece

This part, whose action is simple, can cause a stoppage only when it does not move enough to let the quarter-rack pass, or it has too large detents. It is necessary to take great care when decreasing it, since a good rule is that the quarter-rack must escape before the snail is pushed entirely to the bottom. But let us observe why these parts are unlocked with the first movement made by the push rod, before reaching the snail, which only must cause unlocking, and then it strikes less hours than necessary.

A caser communicated a similar problem to me, whose cause he could not understand. He had given various curves to the detent without having a good meeting, for which a general rule that theory teaches us is: To give to both ends of the detent a compass arc, when the quarter-rack is at rest, drawn from the center of the all-or-nothing piece; I mean the center of its movement which is the end opposite to that of the detent, and to file them according to these lines. The caser did the operation himself, and saw with

astonishment the part act safely. How many repeater makers are still unaware of this rule and succeed only by luck. If one tested all repeaters in this respect, one would find several with this defect. But the owner who is unaware of it, assumes he did not push hard enough, and by redoubling the force it always gives the right hours.

Stoppages caused by star, the hour-snail and the jumper

When the star loses its freedom because of dirt or some other accident, and the jumper cannot turn it, the ray against which the surprise-piece acts is presented in a straight line with it and will stop it, as well as the movement.

The same thing happens if the jumper is stiff and remains at the end of a ray. It is easy to fix that by giving these parts greater freedom, but when they have too much freedom, the most common defect, the jump slips over the star and causes all of the watch to stop. When this problem does not happen, there is another one that too much freedom causes: the star being able to rise will stop the surprise-piece at the moment when it should pass over.

It sometimes happens that the hour-snail passes much too close to the fusee square and stops there. I have seen watchmakers seeking all sorts of other causes for it without thinking of this one, and some lower this step¹¹⁶ and are astonished when the watch miscounts, striking two hours for one; this obliges them to recess all the other steps, a difficult operation which one can avoid by making a throat in the fusee arbor.

Some are astonished to see the winding-rack releasing the striking at midday before it reaches the snail and so striking only four or five hours. This happens when one did not take care to separate the snail from the star. The arm of winding-rack stops on it and returns without going further, a fault which always happens when it is not well retained by its key.

A finisher of a watch, of which I had to examine the repeater-work, found the snail equal and came me saying that it miscounted from six to six.¹¹⁷ When I examined it I found that it had changed position on its star, a guide mark not having been made before removal. If the hole of the snail was true on the canon of the star, and quite round, that would have made no change. But it is easy to see that the hole being too large, it had been thrown and produced this difference from six to six. I turned it over, tightened the hole, and it was right.

How many repeater makers are embarrassed to understand why, for example, a piece will strike all the hours, or certain hours, up to fifty or fifty-three minutes, and from there on it will strike one hour more or less? It is by such problems, though simple to solve, that one can probe the knowledge of those who meddle with making repeaters. When the surprise-piece starts to make the star change the hour, which usually happens about fifty or fifty-three minutes, it moves the snail, making it present the back of the step. If the steps are not notched concentrically and if it is raised, it is clear that if one makes it repeat at this moment it will strike one hour less. Likewise, when the step is deeper at the back it will strike one more hour. When repeater-work makers have left concentric marks, which they should always do, those who finish or examine will do well to look at them. It is certain that some repeaters leave our factories with this defect and very few workmen think of making this examination.

In the provinces, I have repaired repeaters of which the owners had, they said, always noticed this defect. It is also true that this can sometimes appear only after long use, the chain lengthens and unwinds with difficulty to rest on the snail. When the back of the step is presented, which is raised, it will not be able to release the hour.

This is not all. The most delicate test is at 12 hours 59½ minutes. The time that the part must strike is that when it changes the hour; and while pushing immediately afterwards, it must strike the right hour. And half of the repeaters are faulty in this situation. There are some which will strike the next hour and the three quarters at 59 minutes, because the highest step of the snail arrives too early. Others will strike 12 after the 60 minutes because the snail advances too late. The arm of the winding-rack being tilted tends to make it move back to be inserted to the twelfth step, especially if one pushes with force to ensure oneself of this effect. One will drop the winding-rack onto the twelfth step, the hand being at 59 minutes and a half, and while advancing to 60 it will be seen whether the highest step of the snail comes to meet the arm of the winding-rack, and if the jumper passes to the other side of the ray of the star, and is ready to advance it when the winding-rack goes up. And that by pushing back immediately, there is just enough safety; i.e. the snail is advanced beyond the arm of the winding-rack.

There is also another case where pieces will strike the next hour between 59 and 60 minutes. That happens when the arm of the winding-rack does not enter at the beginning of the steps of the snail, in the at-rest state, the steps having moved too early, the following one presents itself before the 60 minutes. It is then necessary to alter the arm of winding-rack or to move back the snail by adjusting the jumper.

This latter case is more difficult to detect and is less frequent than the former.

116 The outer, one-hour step of the hour-snail.

117 On opposite sides; for example at six hours and at twelve hours.

There are many pieces where the star is not well restrained by the jumper and it moves under the pressure of the winding-rack. This displacement happens when the jumper is badly placed, or when its form is not angular enough, and the arm of winding-rack is not directed correctly to the center of the snail, passing on either side; it will tend to make the snail and star slip. The rule is that the outside of this arm must be directed to the center of the snail.

Stoppages caused by the surprise-piece

When the collet which holds the surprise-piece is loose, the button which passes into star will come to a stop against the snail over which it should pass, and it will stop the piece. Or the edge of the surprise-piece could stop against the star, instead of passing over.

If the wheel, or the center arbor which carries the canon, can waver in the frame, and if there is only a little space between the plate and the collet which retains the surprise-piece, it can happen that while turning the hands one will press the canon against the plate. That will tighten against the collet and the surprise-piece will no longer be able to be driven. This event will not cause the piece to stop, but it will cause it to miscount, in that the quarter-rack will be able to descend to the three quarter step of the snail, after the hour without quarter, since the effect of the surprise-piece is to change, in a moment, the hours and the quarters by the impulse of the jumper; and the relationship of these two parts is such that one cannot be stopped without also stopping the other.

One often finds pieces stopped at the time the button of the surprise-piece passes in the star; this happens from 50 to 60 minutes. Whenever pieces are stopped at this time it is necessary first to seek the cause in this passage: if the button is too large, or if it butts against the snail; if it is, on the contrary, too small, it will happen that after having released at 60 minutes, if one makes it repeat at this moment the quarter-rack, while falling on the surprise, will make it return and strike three quarters right at the hour. What happens more often is the arm of quarter-rack will be tilted to facilitate this re-entry. In this case it is necessary to enlarge the button just passing in the star, and without making it move back the all or nothing piece (which would prove that it is too large), so that at the time when the surprise-piece advanced it cannot retrogress, which one tests by pushing it back with a point, and that it has enough safety so that the quarter-rack cannot escape.

As this part requires a high degree of accuracy, and that without putting in a button or another surprise-piece one could not succeed, one will do well to read the chapter on the execution of the surprise-piece.

I will add another interesting observation. When there is only a small space between the surprise-piece and the star, if the latter is not quite true, and if the pin of the quarter-snail (which regulates the movement of the surprise-piece), stands out from the surprise-piece, it will advance the star and the hour-snail, which will be a step in advance on every hour, to the great astonishment of many watchmakers, who do not pay attention to this pin. I have seen some running everywhere to ask for the explanation of this phenomenon.

Stoppages caused by the quarter-snail

This part, being detached from the others, can only cause a stop when it is constrained in its concentric movement by other parts, like the canon of the minute wheel, the spring of the quarter-rack, the all or nothing piece, etc.

As for the first, one should not decrease the snail as I have seen come do, nor remove the safety of the hour without quarter. If one cannot decrease the canon, it should be moved away; if one cannot, then lengthen the arm of quarter-rack by an addition, to decrease the snail. For the second case it is necessary to weaken the spring at the place where it touches, and to make the curve from the base, and it will curve itself sufficiently while moving away.

When, while turning the hands of a stopped repeater, one feels resistance, one finds from that the cause; the surprise-piece being out will stop on the key of the winding-rack, the star or the snail, which one will easily recognize.

Stoppages of repeaters by the case

Although an unfinished repeater functions well in the rough case, it is very common that its behaviour changes when the case is finished. It often happens that during soldering the canon, square etc, it is thrown by the effects of heat, is disordered, loses its roundness and its basic shape, which proves there are inequalities thickness; then the strong draws the weak. In this state the caser repairs it as best he can, making the repeater-work function. The case is then turned over to enamel it, or solder on ornaments, etc. It changes form further in the hands of those who finish it. All those procure the actions thereafter, for which one blames the caser by the way.

If the edge of the case on the side of the canon had been thrown outwards, and if one bends it back while finishing the case, the third quarter will not be able to complete striking, or the locking of the quarter-rack with the all or nothing piece will not be done, being prevented by the push rod, which will return with the canon. This one discovers by opening the movement out of the case; then the third quarter

strikes, and locking is done.

The same happens following a blow given to the case in this place, that many provincial watchmakers have trouble understanding. I saw some who had shortened the teeth of the last quarter, to make it escape, as well as the locking arms. It would be useless to try to make them understand the ignorance of this process: it is well understood that teeth thus shortened will make the hammers rise but slightly, and consequently the last quarter is hardly heard; that moreover there is not enough safety on the quarter-snail for the correct hour; the relaxed locking allows the hour-pallet to descend on the ratchet, and stops the train when not pushed to the bottom.

One should not be astonished if I sometimes repeat what I have said elsewhere. These examples are useful, because one cannot not repeat these points too often; besides I write for the instruction of my pupils.

Let us return to our first case. When the push-piece returns thus, as we said, the first action of those who see it, is to shorten it, so that it allows the completion of the last quarter and locking. What happens? This push-piece, which was the right length, will no longer be able to reach 12 hours. It is thus necessary for the operation, to make sure that there is some left at the bottom after releasing 12 hours. If there is not, it will be necessary to move back the heel of the push-piece from behind, or the part of the case that stops it.

Causes which stop the vibrations of the bell

The parts which one is obliged to attach to the inside of the case frequently stop the vibrations of the bells. Such are: The fastening spring, which one should always place on the side. The least blow to the case will make it touch when it is under the steel plate which holds the push rod; being too near, it can by the same shock also touch the bell. The touch piece, if it is not well fixed, generally obstructs it, especially when the cases are so tight that they leave little space for the bell; and moreover they also have quite light, weak collars. It is impossible for such repeaters to maintain their functions for even six months; carrying them deranges them, and always misleads those who buy them. Several are sent here to give them new bells which are believed to be broken, even according to the opinion of the provincial watchmakers, who do not know how to raise the collar to examine it. The screw which holds it has only to loosen a little to make it approach some of the parts of which I speak.

It is thus very significant to give space in the cases; to fix very well the parts which are placed in the back, while moving them as far as one can from the bell; that the screw is large with a large head, pressed on both sides by a paper lining. There should be a well marked guide mark, so that one cannot change the position of the bell. One understands, without me saying it, that if the hammers are altered they will touch too much or too little, or even not at all, and that if one offsets them, the teeth of the ratchet and the quarter-rack, not being far enough away, will receive the blows of hammers which will express only a half or a quarter of the vibrations of the bell. I have seen watchmakers who, not understanding this consequence, placed the bell at their whim, and allotted other causes to these dissonances. Moreover, if it is not thought of, the touch piece can be too long when the individual uses it; instead of passing over the hammers, it will engage with them to the point of stopping the piece. The opposite happens, when the bell is approached by the hammers which one has made return; then the touch piece, remaining distant, cannot receive the blows.

Particular causes which stop the vibrations of the bell

A repeater was sent here, because from time to time it struck as if the bell had been broken, which happened only at certain hours, and discordantly since the watchmaker of the town had repaired it. I made it strike at every hour, and I found that it happened four times in twenty-four. I asked: which is the mobile which makes only four turns? It is the barrel. Having examined it, I found a monstrous hook, that our empirical watchmaker had put on the chain, and each time it passed in front of the bell, it stopped their vibrations. I in put an ordinary hook and the problem was solved.

It is not rare for barrels placed too far outwards so that they sometimes touch the bell with the chain, and embarrass the repairer who, after having cleaned the inside of the case, will not have noticed the mark, or will have left out a shoulder of paper card, on which the bell had rested. One can be embarrassed, especially when the barrel does not turn symmetrically and touches only occasionally. Badly made false cases also compress the case, pushing the parts inside against the bell, and worry many watchmakers who do not know where to look for the causes so as to recognize them. The false case should be removed and the case pressed everywhere with the fingers, until the sensitive place where the false case presses is found; then the excess in that place is removed with a scraper.

Another repairer let a pillar pin stick out, which touched the bell only when the false case was closed; he could not discover this cause, for which he entirely blamed the false case. He advised the owner to remove it entirely, or at least when he wanted his repeater to strike; which he did for a long time. Tired of this nuisance, he sent it to one our manufacturers, who brought it to me. As soon as I opened it I saw this pin, cut it off, and it sounded and closed well.

I will, for the rest, deviate to compare the provincial watchmakers to those to whom I come to speak, having been witness to the most clever stratagems, put to use by them, to make repeaters function, to which most of our repeater makers would have succumbed more than once. I heard, in the midst of the most famous factories, ridiculous pronouncements on bells which they changed because they sounded badly. I also saw them changing the shape of the hammers, the curve of springs etc, and all without success; because they had not seen that the counter-springs were not well tightened and caused the dissonance. One was possessed with an absurd prejudice for a long time, that the counter-springs should be elastic; experiment proves that, on the contrary they need to be very solid. The return screws are loosened by striking when they are not well held. The least of these defects removes the pleasure of repeaters, and often very little attention is given to them.

To easily judge which of the two hammers touches too much, or when one or the other is raised, listen to the quarters; that which strikes clearly is not the one which it is necessary to return. Some people have assured me that they had removed English bells to put in inferior ones, which sounded better. I tested three of various qualities, but of equal size and height; and I found that those whose form had the best relationship to that of the case had the best sound; which I confirmed by using other cases, in which the same one lost out to the others.

Particular causes which stop the action of the repeater-work

A repeater which had done all its actions as an ebauche, having been gilded and assembled, failed by the neglect of one of those things which one looks at with indifference, and which always make those who do so repent.

The hand, which had been put on at the sixty minutes, moved several minutes from there before releasing the surprise-piece; the surprise-piece left entirely only at five minutes. I say entirely, because at the sixty the jumper passed and remained half way, up to five minutes when it completed its action. The person who assembled it, believing that the surprise-piece was constrained in the star, decreased the button, then made one larger, and changed the shape of the jumper-spring, all without success. He had perverted what was well made, and sent it to me after having wasted much time. Appraised of his lack of success, I examined the star, the jumper and the surprise-piece separately, then their action together, and I clearly saw that at the time when the star was to pass one of the rays, it touched the underneath of the quarter-rack, whose arbor had been tilted to this side when fitting it on the plate. I put it right and all was repaired, to the great astonishment of the repeater maker to see this defect corrected by the arbor of the quarter-rack, But that, you might say, could have been realized at the first by moving the star. Not at all. The friction was so light that the effect was not seen by movement with the hand, but by that of the train, which acted to make this side rise, because I saw that the star wavered, and besides, it happened with only some rays which were undoubtedly higher. This case, which is not rare, is not obvious and is difficult to see, since the least movement of the hand made the star pass.

But here is a case which would produce the same effect, and which few people know of. I was consulted on a watch which did not release the surprise-piece at certain hours, on the point of sixty and, strangely, sometimes at one hour, or six, or nine, etc. As it acted correctly when led by the hand, it was necessary to look at its natural movement. Having raised the dial and examined the passage of the surprise-piece, at every hour, it made several turns without me being able to notice anything. But having turned the canon pinion by hand, and having then let it continue its natural movement; I finally saw the moment when the surprise piece had trouble leaving the star even at five minutes. I mentioned above that it had turned several times without this happening, and consequently it could not be obstructed by inequalities between the rays of star. I thus concluded this effect was produced by the arbor which carries the canon pinion being badly out of round. I removed the balance at once, to watch it turning, and by the variations that I saw it make, I was fully convinced. Indeed, having placed the surprise-piece on the side where the arbor protruded, and making it act gently by the train, it had trouble passing; and when placed on the opposite side it acted very well. To better convince me, I removed the part and put in a good arbor, and then it no longer acted incorrectly. Some workmen in this case would have been satisfied to decrease the button of the surprise-piece, but as I wanted to find the cause, I did not regret time it cost me. Moreover it is a fault which should always be corrected, because it produces bad gearing of the motion work.

I will give another example which, although simple, disconcerted a consummate repeater maker, because of which beginners can be forgiven. He had assembled a repeater with all possible care, however within three days it miscounted one hour, which he could not understand. He consulted several people and then came to me with two experts. With them I made a complete examination, and found everything in order. I advised myself to count the teeth of the motion work, and I found that the minute wheel had one tooth too many.¹¹⁸ "Here", I said to him, "is the cause of the miscounting. Remake the wheel and your

118 I find it hard to believe that a competent watchmaker could not detect this fault without Crespe's help.

The only link between the repeater mechanism and the watch train is by the quarter-snail and surprise-piece

watch will be well." He was dismayed that during eight days of research he did not think of such a simple and natural thing. He wanted to make me accept a gratuity, which I refused, having always been very satisfied when I could render such services. I will add that if I sacrificed my time with similar cases, without any interest, I have tasted a satisfaction that nothing can equal.

Here is another case in point, of a repeater from one of the factories, which has much glory for producing them at a cheap rate, as others have for making good ones. Nevertheless they have their purpose, in that they are useful for education because of the number of defects that they present. These factories serve watchmakers who dedicate themselves to repeaters just as hospitals are necessary to doctors; but their use must be limited, and one must not mislead owners to whom one sells their watches as good. I return to my subject; it is difficult to believe, although my fellow watchmakers have assured me they have seen it. The part had been assembled gilded and it never struck twelve hours. The finisher had already cut the snail by the rule, and had done all that one is accustomed to do. Then it was believed that the cause was in the passage of the winding-rack, the push rod, or the pulleys.

I began, according to the best procedures, by removing the star and its snail, the quarter-snail, as well as the quarter-rack, and made the ratchet retrogress. I saw that after the last tooth, the winding-rack went further and I pushed back gently, counting the hours by the drop of the pallet, (because the movement was in its case), and heard only eleven hours. I repeated the operation. I at once removed the part to count the teeth on the ratchet, and it had only eleven of them. I thought that one of them had broken off, which sometimes happens. Having examined it, I was convinced that there had never been another. I was curious to learn how the watch had been brought to this point, with this defect. I learned from my fellows that the situation was not new, and that the error could come from the train maker, who had not wanted to remake it. That the repeater maker had not taken the time to count them and cut his snails by sight, always in a hurry to finish because of the little money that he was paid. Finally, the caser, not being paid to re-examine the repeater-work, had been satisfied to put the push rod to length on the last tooth which was released with the three quarters striking; he had not bothered to count the hours on the snail as must be done. The repair was expensive for the manufacturer, and I took the opportunity to exhort him to pay for the time of his workmen, to avoid similar nuisances; but I learned that, on the contrary, he had covered this loss by decreasing the prices paid his workmen which were already too low.

Stoppage at 12 hours

The pin which fixes the chain to the pulley often causes problems with the release the twelfth hour, or makes it very difficult. What is more annoying is that those who do not know the rules for its position ascribe this difficulty to other causes, which they try to repair by perverting other parts. There are watchmakers who through ignorance shorten the last tooth to make it pass the pallet; it is so when the hole in the pulley is too low, and then the chain cannot draw it further. In this case the other remedy is to bore a hole above; it is necessary that when the tooth has passed this hole, that is to say is opposite the center of the winding-rack; by which I mean the center of its movement which is its arbor. Repeater makers draw a line from this center to that of the pulley, and place the pin for the chain when the twelve teeth of the ratchet have passed the pallet; but not all know this rule which is invariable. One also expects that by thus moving the chain that it will release the pallet further, and will give one or two hours too many on the snail, in proportion to the different of the position of the chain. It will then be necessary to decrease the pulley or to lengthen the arm of the winding-rack, as may be.

Another stop at 12 hours

This stop, though simple and obvious, can cause the disorder of all repeaters; and because it is not suspected, it is only those who are accustomed to looking at the various parts frequently that see it initially. It is known that chains are prone to lengthen and in this case watches can miscount after some time in service. When one makes 12 hours strike, the quarter-rack gathering-pallet moves too far and its back touches the pin on the quarter-rack, preventing pushing before the quarter-rack drops and nothing strikes. This stop is sometimes so weak that one sees the all or nothing piece moving back, but not enough to release, with the result that some people decrease the locking; the quarter-rack falls and the twelve hours do not strike, because this stop prevents one pushing the winding-rack sufficiently. If the quarter-rack gathering-pallet cannot be moved back, one will make one which, taking the quarters sooner, will leave space for the 12 hours.

attached to the canon pinion. So the only reason the correct number of hours are struck is because the hour hand is put on to correspond with the position of the hour-snail.

Consider motion work with 12 leaves on the canon pinion, a minute wheel of 36 teeth with a pinion of 8 leaves, and an hour wheel of 32 teeth. If the minute wheel had 35 or 37 teeth, then in 12 hours, 12 rotations of the minute hand, the hour hand would advance 11 hours 40 minutes or 12 hours 20 minutes and would be 20 minutes out of synchronisation. In 36 hours it would be one hour out and in 3 days it would be 2 hours out. So at 12 on the third day the repeater would strike 10 or 2.

A problem of another type

One of our finishers, after having wasted much time with a repeater, lost all hope of making it strike twelve hours, and it only struck ten. The winding-rack being stopped by the entry of the plate, the heel and the push rod even touched the great wheel and the barrel. Moreover, the winding-rack touched several parts of the repeater-work. The chain could not be shortened at the ring, because the winding-rack, which goes up higher in this case, could not move further; the push rod could not make space. He consulted and got several opinions. The last, which he came to me to carry out, was to remake the hour ratchet with smaller teeth; together with the damage to the snail, of which he had not spoken, and perhaps of the pallet, that had to be made more closed; the quarter-rack gathering-pallet would have taken them too late.

So one judged the problem, without knowing how to re-assemble a piece properly, and where one must start. It is at this point that I would like to hear from our arguers, without either theory or practice, who destroy repeaters when trying to repair them. Few think of the expedient, which I recognised without even removing the watch from its case. I indicate it with as much pleasure as I got from the bearer, the watch functioning well giving the other two hours.

The small pulley was large, since pushing was long. I decreased it by half a chain link, and made a proportional ring. The winding-rack had less space to traverse to reach the 12 hours, and returned more quickly after the three quarters, so that there was safety everywhere; but it was necessary to lengthen the arm of the winding-rack a little.

To understand this effect properly, it should be observed that the more the pulley (I mean that of ratchet) is enveloped by the chain, the more the winding-rack must move. However, by decreasing its diameter, one also decreases the length of the chain, and by this means the winding-rack will make the ratchet retrogress in less space. It is the diameter of the small pulley which decides the length of pushing, relative to the winding-rack.

Unexpected stoppage of the movement

A repeater, after having worked for some time, miscounted by striking one hour less at every hour, as often happens from the lengthening of the chain. The watchmaker doing what appeared natural to him, shortened the arm of the winding-rack. Finally he had repaired it, but much was his astonishment when the following day he found the piece had stopped, and it did not appear to be due to the repeater-work. He had not touched the movement, which had never stopped, and he could see no cause which would stop it. However, he lifted out the balance and the train ran very well, then the piece continued to run in the same way and to stop a few hours afterwards. On the report that he made to me, that he had done nothing other than shorten the arm of the winding-rack, I observed that by this he obliged this part to penetrate further into the frame, together with the push rod, so that one or the other could have reached the large fusee wheel and to have broken teeth. I removed the movement from its case and, pushing at midday, I saw clearly that the push rod reached the teeth of the wheel. I removed the balance to examine them and I found, indeed, that there were no broken teeth, but they were bent enough to butt. I then straightened them sufficiently to ensure they would not butt, and I assured myself that there was no other cause, as that succeeded very well. But I advised him to disassemble it to repair this disorder properly, without forgetting to give the push rod the necessary passage.

I have seen similar cases which have appeared only after several months of service, because they had not been pushed at midday. They are very frequent with common watches because, as I mentioned above, the finishers only do the obvious, being in a hurry to complete. The payment of these workmen should be unlimited, since it is true that no repeater leaves our best factories on which a skilful expert did not find much to do.

Stop by the delay

There are few experts who have not seen many watches stopped by the delay, and it seems that it is arranged so as to produce this result, by giving to the owner the means to adjust it. Since it should be adjusted by only the hand of the watchmaker, it would be better to make in the style of the English, like the head of a screw, and then the owner could not touch it. It would be better still if it were made in a way so that it could neither stop the train nor break pivots, by limiting its movement; because a great number do not even have a hand or an index. A person who ill advisedly turned this key and broke the pivot of the delay, complained to me. Two of our manufacturers assured me that they had had watches returned to them from afar to fix this problem. It is seen all the time, but it is not corrected by anyone.

Unforeseen case

An owner complained that his repeater, which had always functioned well, no longer struck the right hour at the indications of the dial, and even 5 minutes afterwards it still struck the previous hour and three quarters, and likewise with all the following quarters. I turned the hands at once, and I heard that indeed the surprise-piece only came out at five minutes. Then, making the quarter-rack drop on a high

step of its snail and continuing to turn the hands, I heard it to drop five minutes after each quarter. Then, not allowing it to strike and holding all parts down by the push-piece, I continued to turn the hands, which were at the five minutes, the snail pressing on the quarter-rack which should have stop strongly if it had been well riveted to the canon, which turned by itself, with some trouble. Without going further, I asked the owner of the watch if, while it struck 12 hours and three quarters, he had turned the hands? He told me that at that hour he wound it and set it to his clock when they differed, and that he had felt some resistance at this moment. It should be clear that I had little trouble repairing it, by turning over the canon to make it hold solidly. I observed that this watch struck slowly, which gave me time to turn the hands. The same result could have been achieved by turning it back on the step of the second quarter, that the quarter-rack would have stopped; then it would have struck the right hour on sixty minutes, according to how much one had turned it back.¹¹⁹

One sees by this that the least negligence can disturb all the functions of repeaters, and I am persuaded that the majority of finishers, even the most careful, do not think of checking the solidity of the quarter-snail on the canon; which one does easily by examining all the steps of the snail, dropping the quarter-rack while turning the canon with force when the hand is there.

Movement of the hands by pushing the repetition

It is not rare to see repeaters where, when one pushes to make them repeat at certain hours or minutes, the hands turn and advance up to fifteen minutes. Several causes can produce this effect. The most common is when the collet of the surprise-piece is loose, and the winding-rack meets the button and pushes it. When the key of the winding-rack is loose, the arm can rise and produce the same effect.¹²⁰

These cases are easy to recognize and repair. But what embarrasses the workmen who do not know the principles of repeater-work, and which is difficult to know how to correct, is when the support of the arm of the winding-rack on the snail causes it to turn at the time when the surprise is engaged in the star, and consequently makes it turn with the hand. This case happens when the arm of the winding-rack is not directed to the center of the snail. If it passes beyond, it will advance the hand, and it will make the hand move back if it is inside. The only remedy is to make this arm go to the center of the snail; that is to say, by replacing the winding-rack or by curving the arm.

How to find the causes which stop the functions of repeater watches

If the push-piece is up when at rest, one must suspect that the stop is in the movement. It will be opened to see whether the balance or some of the wheels are locked.

If pushing is free, going and coming, the cause is in the repeater-work and it should not be sought elsewhere. The dial will be removed, and it will be found that the quarter-rack has dropped on the snail and did not return, and consequently all the functions stopped. The causes of this stop will be: 1, stoppage of the repeater-train; 2, the quarter-rack return pallet rising because someone has forgotten to pin it or the pin has fallen out; 3, by the drop of the pin on the quarter-rack by which it is brought back; 4, when the stud which carries it loose and it locks at its ends; 5, when it is constrained on its stud by thick oil, dirt or a spring which is too strong and holds it with those of the hammers, which the motive power cannot overcome; 6, when the center arbor has play, the quarter-rack having gone down a little low, the quarter-rack return pallet will not have enough catch, and will prop against the pin, which will bring both to a stop. And lastly, if one or the other of the pallets is not brought back by its spring, it can be presented in opposition to the quarter-rack and stop it.

All these causes of stoppage can be suspected initially when the hand is at 58 or 59 minutes. When the chain breaks or is unhooked, the winding-rack remains at the bottom of the snail and stops against it; then the piece will stop at 12 hours and 58 minutes.

If a repeater falls on its dial and the glass breaks, the arbor which carries the hands bends, and the watch is stopped by the surprise-piece which is forced into the star and is held there.

When, on the contrary, a repeater falls on its back and if there is only a slight depression, the bell or its screw can obstruct the balance and it will stop. One recognizes this when it runs with the case open.

If one of the hammers is loosened by striking and it touches the wheels, stopping is inevitable, and it is easy to recognize because it is constrained at the point and cannot be returned by its spring. If the large-hammer is free in the frame it also stops the movement, because the spring broke, or it has escaped from its pin, or the pin fell out or broke.

When the hour-pallet meets, in straight line, the end of a ratchet tooth whose point is not quite round it butts and the stop is very strong. This case happens when the steps of the snail are inserted too far.

When the jumper is stiff or when its spring has risen, or is out of place, the star not being in its at-rest

119 Fixing one evil by another! The quarter snail being loose on the canon pinion, it can be forced backwards to fix the wrong striking caused by forcing it forwards.

120 There is not much clearance between the winding-rack hour-snail arm and the surprise-piece. If the arm meets the surprise-piece button, the surprise-piece will be turned, turning the canon pinion with it.

state, it will present a ray against the surprise-piece and will make a strong enough opposition to stop it, and consequently the whole movement.

If the arbor which carries the minute wheel is loose, or even when it is bent, the passage of the snail will be obstructed and will be stopped.

When the pin which retains the surprise-piece has come out, the surprise-piece will drop and will stop, encountering the winding-rack or the hour-snail.

When a stop is suspected in the repeater-work without apparent cause, one must loosen the arbors and the screws which go near wheels, which can have play and touch the protruding stems. For example, the wheel of the fusee being loose, the teeth will come, in time, to stop against the arbor of the winding-rack, the barrel on that of the pulley, the center wheel on the key of the winding-rack, or the minute arbor; the third wheel on the arbor of the all-or-nothing piece, etc. By this means one will find the true causes of stoppages that one has searched elsewhere for a long time.

One should never make a repair except after having made a complete examination of all the causes which can produce stops, and to have made certain of the existence of that which one wants to repair.

The steps to examine the repeater mechanism to secure its actions

One will make it strike, before opening the bezel, on a horizontal surface, which is the most normal. Then while turning it on all sides, because there are some which stop on being turned over, or strike with more or less speed; then hung up by the bow; and finally hung by the push rod, which is the hardest test because it has to overcome all its weight. If, in this state, it strikes twelve hours and three quarters freely one is certain that it will not fail in its action in the ordinary positions, and any piece well made must pass this test.

While a repeater strikes twelve hours, one will press on the case in various places, to see whether it compresses on some part which makes it stop or hinders its running, which happens particularly when the cases are thin.

One will make it strike at twelve hours and 59½ minutes to see whether the surprise-piece, having led the snail to the point to change the hour, still makes it possible for the winding-rack to penetrate to the bottom of the twelve step; and during the time that it rises up, the snail advances to present the next hour. Then one pushes hard enough on this step to make sure that it does not retrogress. This passage being the most difficult for repeater-work, one must give scrupulous attention to it.

One will make it strike against the silencer, by gently pressing the button to see if there is good interval between the arm of the silencing device and the spring, or if there is not a long enough interval which would obstruct the action of the hammers on the bell. One will see if the two hammers can be felt easily by the finger. One then presses very hard to see if there is a stop which prevents it from making the hammers rise too much. One sees if it returns freely, and does not engage with the pallet or some other part. One sees whether the outer case presses on the point of the button to intercept the blows of hammers.

It will be carefully observed if the outer case changes the blows of the hammers and the vibrations of the bell or gongs by compressing the case in some places. When it advances or moves back the hammers or the bell; this happens when they are not round, the cases are light and the plates loose in the movement seat. It will be the same when the bezel is not round and the bezel is weak; it will change the effect of the blows of hammers. I have often changed the harmony of a repeater by changing the glass.

The outer case will be removed, the bezel opened, and one will examine the effect of the touch piece, by moving it half way and making it strike, to see if in this position, one or the other of the hammers does not meet it. Then it will be moved completely to make sure that the hammers meet it in full, and that it is not so free that it can move away while striking and touch the bell. In this state one will open the movement to see whether, when closing again, the hammers are held by the touch piece, which will break the pivots on the hammer arbors when they are forced to enter.

One will check the fastening spring which can obstruct the large-hammer as well as opening when not being touched, if the bezel does not let it return, and intercept the blows of the hammers. I have seen watchmakers searching everywhere because they did not suspect this cause.

The push rod will be examined to see if it is too short, if it releases twelve and a half hours freely, and allows the three quarters to strike with locking of the all or nothing piece. For this one will lead the push rod half way to make sure that the quarter-rack is locked and that consequently it does not strike. One will see whether, after having pushed at twelve hours, it can still push the winding-rack, in the event of the chain lengthening. And if it moves easily over its length, and returns up by itself without having to withdraw it.

One will then open the cover of the case to examine the functions of the repeater-work. One will turn the hands with a key, to observe if the hour changes at the 60 minutes point for all of the 12 hours, which one must hear distinctly. If some hours change earlier or later, it would prove that the star is not quite equal.

One will then examine the divisions of the quarter-snail, which is done by putting the hand at five

minutes¹²¹ and, while pushing to make the quarter-rack drop, one will retain the repeater train by a finger and gently turn the minute hand, in order to test that the drop of the quarter-rack is correct at each quarter.

One will then make it strike the exact hour to see whether there is enough safety not to give a blow too many. In the same way one will test each quarter to see whether the steps are correct and strike neither more nor less. And as there are snails whose steps are not notched concentrically, one will test the strike at various places. The same observations must be made for the hour-snail, if it strikes the hour indicated correctly when the hand is turned to 55 or 59 minutes. While making it strike in these positions, it will sometimes give an hour more or an hour less, because the surprise-piece, having moved the snail, makes it present a different part of the step, which if cut in more will make the watch strike one hour more, and if it is less it will strike one hour less. A great number of pieces have this defect for a long time because it is only discovered when one makes them strike at this point.

There may still remain some defects which one has not been able to correct as yet. For example, making the hour retrogress in a short space of time. When the owner of a repeater, who has done everything to ensure he has a good piece, suddenly turns the hand back five minutes after the hour and he pushes in at this moment, it will strike the last hour instead of that indicated by the hands. This is because the surprise-piece did not have enough time to turn back the snail, and the owner complains that his watch does not strike with the indications. This is why it is advisable to inform those who buy a repeater of this defect, while waiting for someone to find a way of handling this change, at least in a minute, which I believe is very possible.

END

121 Only the 0, 1 and 2 quarter steps can be tested by this method.

